

UNIWORLD

BOUTIQUE RIVER CRUISES



CELEBRATING  OF EXCELLENCE
YEARS



TINY NOTICEABLE TOUCHES™

Unparalleled luxury found in every detail

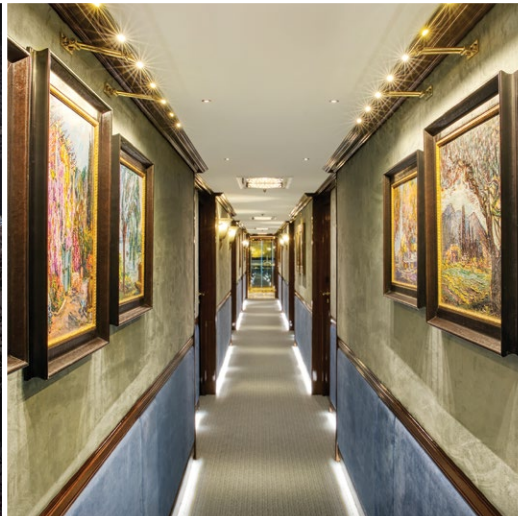

Welcome Aboard

The moment you step aboard one of our *Floating Boutique Hotels*, you enter a world of unparalleled luxury, infused with the warmth of our service-driven crew and an immersive atmosphere that brings to life your travel destinations.

Ever since Uniworld was first founded in 1976, it has been our joy to bring travelers on one-of-a-kind journeys in our favorite places around the world. Now, our world is wider than ever, with trips spanning **Europe, Southeast Asia, Egypt, India, and South America.**

Find your inspiration in the pages of this brochure, where you'll find classic river cruising experiences on the **Rhine** and **Danube**, as well as indulgent voyages in **France, Portugal, and Italy.** For those looking to explore off-the-beaten-path, **Extraordinary Destinations** such as the **Mekong Delta** and the **Peruvian Amazon** offer the luxury adventure of a lifetime.

We're excited to introduce several new itineraries and extensions, including a spectacular new cruise through the **Wine Roads of France & Portugal**; an Italian itinerary connecting **Milan, Venice & Rome**; a new **Holiday** offering in Belgium; a 15-day grand discovery of **Central Europe**; and a new **Cruise & Rail** route connecting **Paris & Istanbul**, two of the most storied destinations on the continent. Uniworld guests can now extend their journeys in more destinations on land, such as **Biarritz Basque Country, Madeira Island, and Mediterranean Cassis.**

Keep an eye out for two new members of our Super Ship™ fleet in Europe. The **S.S. Elisabeth**, sister ship to the S.S. *Victoria*, will set sail in 2025. Then, in 2026, the **S.S. Emilie** will debut with a chic design inspired by the works of Gustav Klimt.

Wherever you plan to explore next, do it in the extraordinary style of Uniworld. After all, ***you deserve the best.***

Ellen Bettridge

ELLEN BETTRIDGE

CEO
UNIWORLD BOUTIQUE RIVER CRUISES

-
- 2 CELEBRATING 50 YEARS
 - 4 WELCOME TO LUXURY RIVER CRUISING
 - 20 WESTERN, CENTRAL & SOUTHEAST EUROPE
 - 46 PERU, SOUTHEAST ASIA, INDIA, EGYPT
 - 56 HOLIDAY SEASON CRUISES
 - 58 CRUISE & RAIL
 - 62 RIVERS OF THE WORLD CRUISE
 - 64 ONE-OF-A-KIND SHIPS
-



Ever since we first set out to take travelers on one-of-a-kind trips in 1976, Uniworld has been all about the guest-driven approach. We listen, we research, and we innovate—not only to discover what our guests are telling us they want and need, but to also anticipate what they are missing out on. That’s how you get to the heart of what a great vacation really is.

As the first American company to cruise the rivers of Europe, we’ve had the time to learn along the way and reinvent the format entirely. Uniworld lengthened cruise itineraries to one, two, even three week stretches, and introduced all-inclusive pricing. We handpicked destinations our guests would be looking for, then snuck in a few hidden gems we just knew they’d come to love. Perhaps most importantly, our ships offered the boutique hotel experience early river cruisers desired: designs with character, hotel-style beds, and delicious onboard dining. And by making their favorite boutique hotels float, now our guests could travel in all-inclusive luxury to multiple destinations, without having to unpack between each stop.

But we didn’t stop there. Every year, we pay close attention to the world of travel and the feedback of our guests to create better and better travel experiences. When we joined The Travel Corporation’s collection of award-winning travel brands in 2004, our mission became elevating river cruising to new heights. We launched the **Super Ship** fleet, began cruising in more extraordinary destinations, and introduced innovative new concepts as **Cruise & Rail** journeys, **Nights Out**, and **MAKE TRAVEL MATTER® Experiences**. Year after year, we set new standards and expectations for what luxury river cruising could be and are looking forward to continuing these pursuits for the next 50 years.

“The service was superb! All of the staff were always smiling, very courteous and made us feel very special. We actually felt like royalty in how they treated us. Thank you for making our trip so enjoyable!”

– Gwynne, ENCHANTING DANUBE

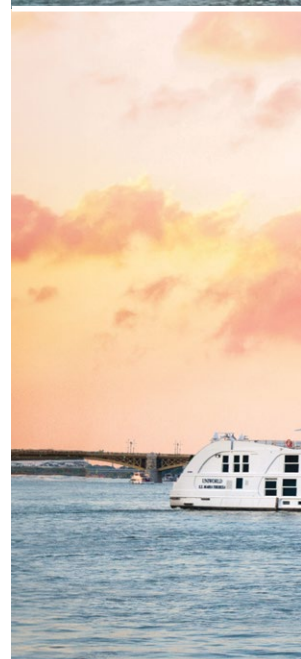



WELCOME TO LUXURY RIVER CRUISING

This is cruising at its absolute best

Sailing by river means enjoying all the conveniences of a traditional cruise, along with all the benefits of land travel. Stopping in multiple destinations on every trip, you'll visit bustling cities and hidden gem villages, unpacking only once. River cruising is the best way to cruise, and the best and most luxurious river cruises are with Uniworld.



S.S. Beatrice sailing



ONE-OF-A-KIND BOUTIQUE SHIPS

One of the highlights of your river cruise will be the ship you sail on. Each of our one-of-a-kind ships is like a floating boutique hotel; designed to immerse you in the destination with luxurious amenities, beautiful public spaces, and elegant dining venues.



ALL-INCLUSIVE AMENITIES

Everything you could ever need is included with Uniworld. From your meals to premium drinks, plus your daily shore excursions. We've even included the onboard gratuities. All you have to do is sit back, relax and enjoy the Uniworld experience.



INTIMATE & RELAXING EXPERIENCE

Compared to ocean cruising, a river cruise ship is smaller and offers guests a far more intimate experience. With just an average of 120 guests onboard, you can get to know your fellow travelers and receive better access to the incredible staff onboard.



UNMATCHED CONVENIENCE

River cruising allows you to travel directly through the heart of countries, giving you access to some of the world's greatest cities right outside your window. You'll travel to multiple destinations with ease, only unpacking once.



IMMERSIVE TRAVEL EXPERIENCES

We've selected culturally immersive experiences on every journey. These range from a private after-hours visit to St. Mark's Basilica to receiving a breathtaking water blessing from a Cambodian monk.



CONNECT & STAY CONNECTED

Unencumbered by large crowds, you'll effortlessly meet people who share your passion for travel and exploration, and stay connected with loved ones back home with complimentary shipwide Wi-Fi.

ONE-OF-A-KIND SHIPS

inspired by their destinations

The ships in our fleet are passion projects, through and through. Every unique design scheme is assembled to be a masterpiece in and of itself. To step onboard a Uniworld ship is to step into a world where your destinations come to life through every carefully considered detail. We don't believe in filling the rivers with a large fleet of identical ships. We believe in quality over quantity.

OUR DESIGN ETHOS

Each ship has a distinctive theme, with its own color palette, custom-made fabrics, personally selected artwork, sumptuous furnishings and antiques. Every element, down to the smallest detail, has been thoughtfully considered and flawlessly rendered.

OUR SUPER SHIP FLEET

The members of our **Super Ship™** fleet completely transform the standards of river cruising. These vessels add a layer of luxury through multiple dining venues, more suites, and **Tiny Noticeable Touches™** throughout.

THE FINEST AMENITIES

Our lavishly appointed staterooms feature handcrafted Savoir® Beds of England, high thread count 100% Egyptian cotton sheets and European duvets, a menu of pillow options, and Asprey bath and body products.



THE SUITE LIFE

Like our ships, all of our suites have been uniquely designed. Each suite has a distinct personality, boasting additional space, custom upholstery, complimentary mini bars, special in-room treats, and the services of a personal butler.



Scan code to watch a video about our suites



THE MOST ALL-INCLUSIVE AMENITIES

Don't settle for anything less

There's all-inclusive, and then there's the unmatched level of inclusive luxurious amenities that only we provide. To ensure truly carefree and effortless travel, we've gone ahead and included it all—so the only thing you have to do is sit back, relax, and enjoy the Uniworld difference.

- ✓ **ALL GRATUITIES ONBOARD**
- ✓ **UNLIMITED BEVERAGES**
including fine wines & premium spirits
- ✓ Award-winning
FARM-TO-TABLE CUISINE
- ✓ Choice of
MULTIPLE DAILY EXCURSIONS
- ✓ **PERSONAL BUTLERS**
exclusive for suite guests
- ✓ **SCHEDULED AIRPORT TRANSFERS**
for guests who meet Transfer Guidelines
- ✓ **ONBOARD ENTERTAINMENT**
- ✓ **COMPLIMENTARY BICYCLES**
- ✓ **DAILY FITNESS CLASS**
- ✓ **24-HOUR ROOM SERVICE**
- ✓ **SHIPWIDE WI-FI**
- ✓ **SELF-SERVICE LAUNDRY**

NOTE: Amenities may differ in Peru, Egypt, India, and Vietnam & Cambodia.





THE ONLY THING MORE STUNNING

than stepping onboard is stepping off

Every Uniworld cruise is meticulously crafted to be an experience you won't find anywhere else, filled with moments that are each more breathtaking than the last. We've gone the extra mile to ensure our included and optional excursions immerse you in the authentic culture, sights, and cuisine of the places you'll visit.



Abu Simbel, Egypt



LET'S GO

Our active excursions invite you to appreciate the natural world with invigorating walking, hiking, cycling, kayaking, and golfing activities.



DO AS THE LOCALS DO

Whether we're seeking local favorite treats or chatting with small business owners, these tours capture what it's like to live in the destinations you visit.



PRIVATE EXPERIENCES

From visiting a museum without the crowds to an after-hours tour of a famous landmark, these once-in-a-lifetime experiences are arranged just for Uniworld guests.



NIGHTS OUT

From private concerts to local nightlife experiences, this line of included excursions goes the extra mile to bring you uniquely memorable moments.



MAKE TRAVEL MATTER®

These sustainably minded excursions offer our guests opportunities to directly impact the communities we explore in a positive way.



MASTERPIECE COLLECTION

If going above and beyond is what you're after, you'll be sure to enjoy our selection of *Masterpiece Collection* optional experiences, available for an additional cost.

WANDERLUST MEETS WELLNESS

onboard and onshore

If sitting still isn't exactly your style (though you certainly can if you want to), you'll find you're right at home. Each day of your cruise features several options to get up, get going and stay fit, both onboard and onshore. Our seasoned wellness experts continuously hone their craft with yearly Ayurveda yoga and other training, lending their expertise to you onboard.



Sunrise yoga, Budapest, Hungary



LET'S GO EXCURSIONS

Our *Let's Go* onshore program features guided walking, hiking, kayaking, golfing, cycling, and more. Experience Bavaria's great outdoors on a bike ride from Passau to Engelhartszell, or through the Médoc vineyards. Hit the links with a round of golf at Golf d'Étretat, perched on the French hilltops, more than 150 feet above sea level. Wherever your journey takes you, there will be many opportunities to get out and go.



TRAVELING LITE MENU

For those interested in healthier dining options, our *Traveling Lite* menu features all the flavor of our traditional menu, but with fewer calories. We also offer a variety of vegetarian and vegan options, prepared just for you. If you have a specific meal preference, just ask. Our chefs will be happy to accommodate.

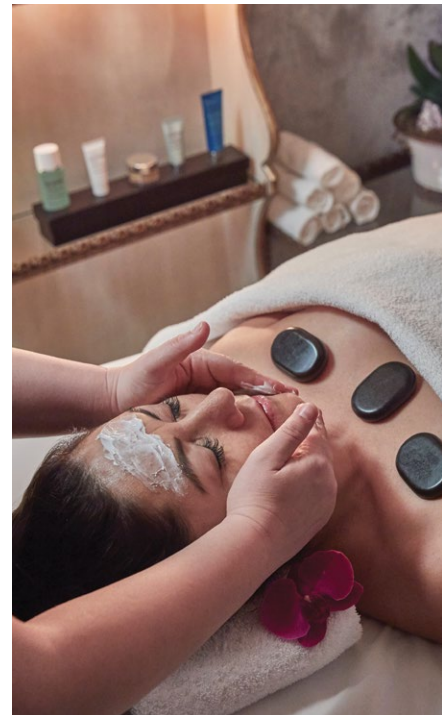

WELLNESS ON THE WATER

During your time cruising with us, you'll want to take advantage of our unique *Wellness on the Water* programs and amenities. Start your day with sunrise yoga on the top deck or work out at your own pace in the fitness center. Afterwards, relax at the **Serenity River Spa™** with a soothing facial or massage treatment, or take a dip in the heated pool (available on select ships).

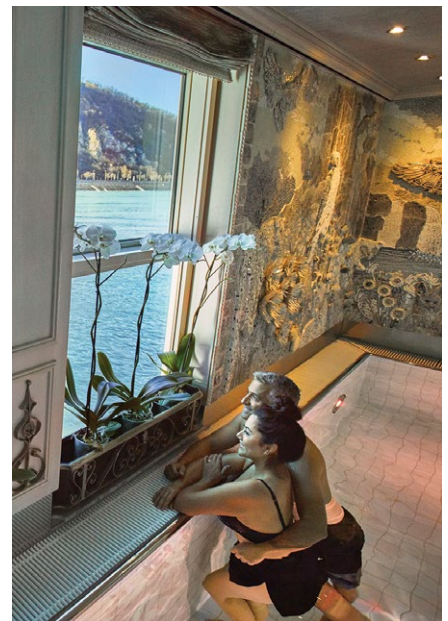

CULINARY EXCELLENCE

We treat cooking as an art form

Our culinary philosophy is ever-evolving, designed to appeal to the discerning palates of international travelers, with a variety of traditional dishes, inspired contemporary flavors, delicious healthy dining options, and comfort cooking. From breakfast to lunch to dinner, each meal is carefully crafted exactly to your tastes.



Chef Robert van Rijsbergen, Director of Culinary Operations



A CUT ABOVE THE REST

Uniworld's kitchens attract a particularly talented team of chefs, every one of them passionate about turning local ingredients into culinary masterpieces. Their work has even earned them recognition by the prestigious gastronomical society, **The Chaîne des Rôtisseurs.**



OUR RECIPES, CATERED TO YOU

For those interested in healthier dining options, our *Traveling Lite* menu features all the flavor of our traditional menu, but with fewer calories. We also offer a variety of vegetarian, vegan, and gluten-free options, prepared just for you. If you have a specific meal preference or desire, just ask.



ENDLESS POURS

With every meal, enjoy a choice of featured fine local wines, selected by our onboard sommelier, grown and bottled directly from the regions you visit. Not restricted to a dining room or even the bar, you can ask our bartenders to bring you all the premium wine, beers, spirits, and signature cocktails you desire.





La Cave des Vins sommelier, S.S. Bon Voyage

THE MOST PERSONAL SERVICE

for every guest

Our outstanding crew onboard are the driving force behind our guest-centric atmosphere and the reason you leave your cruise feeling like part of the family. It's very common you will find staff members who have worked solely for Uniworld for over ten years. To ensure every guest is thoroughly looked after, we offer the best staff-to-guests ratios in the industry..

NO REQUEST TOO LARGE

Our goal is to give you the unique and unforgettable experiences you seek, with the personalized, industry-leading service you deserve.

2.4 TO 1 GUEST-TO-STAFF RATIO

With the best staff-to-guest ratios on the rivers, each guest receives our crew's full attention and unmatched attention to detail.

TINY NOTICEABLE TOUCHES

The tiniest details often draw the brightest smiles. Our staff's passion is apparent in their attention to your interests, like remembering your drink order from day one, or surprise you with chocolates from a local shop you mentioned in passing.

IN-SUITE BUTLERS

Our butlers are trained to the highest standards in the industry. Each assumes the role of butler 100% of the time, and doesn't moonlight in other roles, enabling to focus fully on making your cruise one to never forget.



COMBINE YOUR PASSION WITH A LUXURIOUS GETAWAY

on a specialty-themed cruise

Want to dive deeper into a particular aspect of your destination's culture or take your interests abroad with you? Join us on a Themed or Limited Edition cruise, available on select sailings only. These cruises offer exclusive programming, onboard and onshore, for a truly unique experience of the places you visit.

PREMIUM GOLF PACKAGE

This add-on to our Bordeaux cruise for summer 2025 comes with two 18-hole rounds at top-rated courses and other convenient inclusions for golfers.

Brilliant Bordeaux: page 38

MUSIC OF THE DANUBE

Embrace the musical heritage of the Danube on a week filled with private concerts, special excursions, and local entertainment onboard.

Enchanting Danube: page 30

WOMEN-ONLY CRUISE

For our August 24, 2025, sailing in Burgundy & Provence, we've added a plethora of exclusive excursions and events designed by women, for women.

Burgundy & Provence: page 37

JEWISH HERITAGE PROGRAM

Embrace Central Europe's rich history and Jewish ties. This program is a complimentary alternative to the traditional itinerary. On our two in-depth cruises, you'll venture off the beaten path with excursions highlighting Jewish-inspired architecture, memorials, museums, synagogues, and more.

Remarkable Rhine & Historic Holland: page 25

Delightful Danube & Prague: pages 28-29

GENERATIONS COLLECTION

These family-friendly sailings in Europe and Egypt include additional amenities for young travelers, such as onboard Family Hosts to oversee activities and shore excursions curated for families.

Castles along the Rhine: page 24

Enchanting Danube: page 30

Splendors of Egypt & the Nile: page 54

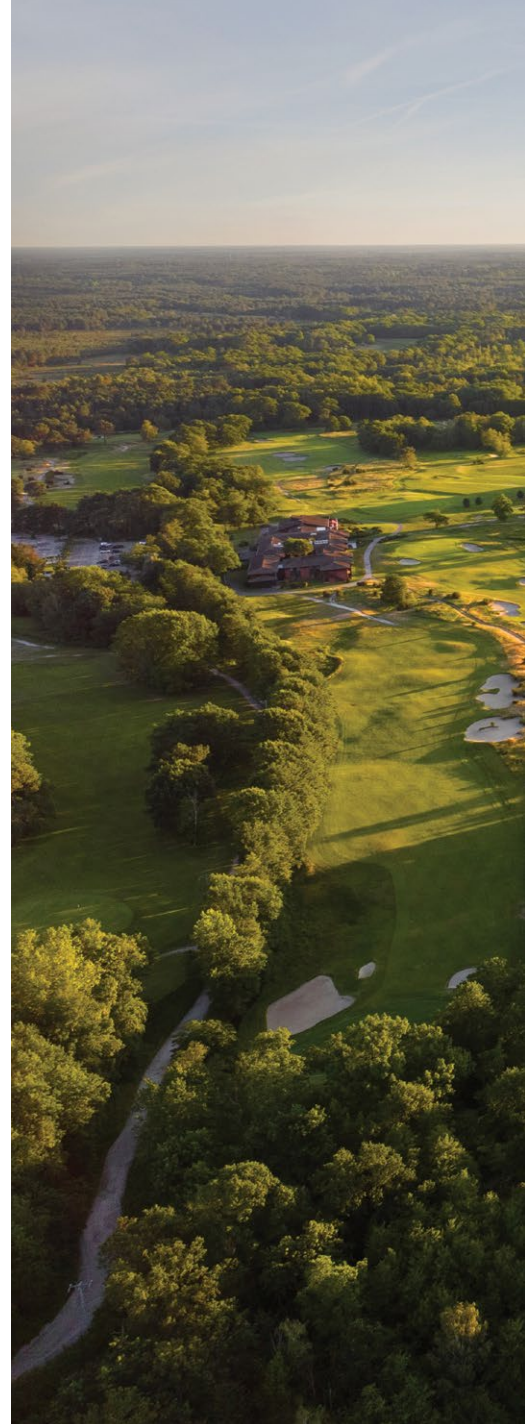



Cabot Bordeaux Golf, Restaurant, Spa et Hôtel MGallery, Bordeaux, France





EUROPE

*Beloved destinations
to steal your heart away*



Danube River, Wachau Valley, Austria

DOURO: Portugal, Spain

DORDOGNE: France

GARONNE: France

RHÔNE: France

SAÔNE: France

SEINE: France

MOSELLE: France, Germany

DANUBE: Austria, Bulgaria,
Croatia, Germany, Hungary,
Romania, Serbia, Slovakia

MAIN: Germany

RHINE: France, Germany,
The Netherlands, Switzerland

DUTCH & BELGIAN WATERWAYS:
Belgium, The Netherlands

VENICE LAGOON: Italy

HOLLAND & BELGIUM AT TULIP TIME

8 Days • Brussels to Amsterdam • S.S. Victoria



Amsterdam, the Netherlands



Peak bloom for tulips is the most magical time of the year. Make the most of this short season with a visit to Keukenhof, the world's largest flower garden, and a *Nights Out* at the A'DAM LOOKOUT observation deck overlooking Amsterdam. Just as delightful are Castle Loevestein and a *Village Day* experience in the small town of Gorinchem.

DAY 1
BRUSSELS
Embark

DAY 2
BRUSSELS
Brussels city tour with waffles

DAY 3
ANTWERP
Taste local treats in this iconic town

DAY 4
HASSELT (MAASTRICHT)
Walk around "Europe's smallest metropolis"

DAY 5
GORINCHEM
Gorinchem *Village Day*

DAY 6
GORINCHEM, KINDERDIJK
Visit Kinderdijk Windmills or go on a *Let's Go Biking* the Dams and Windmills

DAY 7
AMSTERDAM
Nights Out Lookout Tower Amsterdam

DAY 8
AMSTERDAM
Disembark

UNIQUELY UNIWORLD

Learn about Belgium's beer culture during an onboard lecture and tasting led by a local beer sommelier.

Visit Keukenhof, one of the world's largest flower gardens, and admire a haven of blooming tulips in the most colorful symphonies.

Includes at least one **MTM Experience**.

MAKE TRAVEL MATTER
EXPERIENCE



WE SUPPORT THE SUSTAINABLE DEVELOPMENT GOALS

SNAPSHOT

7 Nights Cruising

11 Included Excursions

4 UNESCO World Heritage Sites

19 Meals (including 1 Welcome Dinner and 1 Farewell Dinner)

DEPARTURES

March - April



Brussels, Belgium



Belgian waffle



Scan code for detailed
itinerary information

Uniworld.com/Holland-Belgium

TULIPS & WINDMILLS

10 Days • Amsterdam to Antwerp • *River Duchess, River Princess, or S.S. Emilie*



Dutch windmill and tulip field, the Netherlands



Welcome the season of spring with tulips, windmills, art, and picture-perfect villages. This cruise takes you through medieval city centers and historic villages. Float through the canals of Bruges, known as the “Venice of the North.” And, of course, soak in the sunshine while strolling around the windmills of Kinderdijk and the tulip gardens.

DAY 1
AMSTERDAM
Embark

DAY 2
AMSTERDAM
Nights Out Lookout Tower Amsterdam

DAY 3
HAARLEM/ZAANDAM*
Stroll among millions of colorful flowers in Keukenhof

DAY 4
ENKHUIZEN/HOORN*
MTM Experience Dutch cheese trail

DAY 5
NIJMEGEN
Visit the Kröller-Müller Museum

DAY 6
ROTTERDAM (KINDERDIJK)
Sustainable MTM Experience in Rotterdam



Dutch cheese market



Bruges, Belgium

DAY 7
VEERE
Stroll into the Artists' Village of Veere

DAY 8
GHENT (BRUGES)
Cruise through the city center of Bruges

DAY 9
ANTWERP
Visit Antwerp's striking Cathedral of Our Lady

DAY 10
ANTWERP
Disembark (Brussels airport)

**In 2026, Day 3 docks in Zaandam, and Day 4 docks in Hoorn.*

UNIQUELY UNIWORLD

Delight in a “Morning at the Fabrique de Lumière.”

Enjoy a *Let's Go* bike ride through the dams and windmills of Rotterdam.

Add an optional *Masterpiece Collection* excursion to the city of Delft, known for hand-painted blue & white pottery.

Includes at least one **MTM Experience**.

MAKE TRAVEL MATTER
EXPERIENCE



WE SUPPORT THE SUSTAINABLE DEVELOPMENT GOALS

SNAPSHOT

9 Nights Cruising

22 Included Excursions

4 UNESCO World Heritage Sites

25 Meals (including 1 Welcome Dinner and 1 Farewell Dinner)

DEPARTURES

March - April



Scan code for detailed itinerary information

Uniworld.com/Tulips

CASTLES ALONG THE RHINE

8 Days • Basel to Amsterdam • *S.S. Antoinette*, *S.S. Elisabeth*, or *S.S. Victoria*



Picture yourself on the sun deck, wine in hand, passing by dozens of medieval castles. This fantasy is brought to life on this stunning cruise through vineyard-lined valleys, sweeping panoramic landscapes, and fairytale towns. Savor a wine tasting at Castle Vollrads, learn about medieval history and wander through towns that appear stuck in time.

DAY 1

BASEL

Embark

DAY 2

BREISACH

Explore storybook Alsatian villages

DAY 3

STRASBOURG

See the highlights of canal-lined Strasbourg

DAY 4

MANNHEIM OR SPEYER

MTM Experience Private Doktorenhof Vinegar Estate visit and tasting

DAY 5

RÜDESHEIM, BRAUBACH

Enjoy wine tasting at Castle Vollrads

DAY 6

BRAUBACH, KOBLENZ, COLOGNE

Let's Go bike the castles from Boppard to Koblenz

DAY 7

COLOGNE

Explore Cologne's Old Town

DAY 8

AMSTERDAM

Disembark

UNIQUELY UNIWORLD

Create memories with an itinerary suited for the whole family on select **Generations Collection** sailings.

Stroll through picturesque Breisach, your gateway to the Alsatian wine road.

Includes at least one **MTM Experience**.

MAKE TRAVEL MATTER
EXPERIENCE



WE SUPPORT THE SUSTAINABLE DEVELOPMENT GOALS

SNAPSHOT

7 Nights Cruising

11 Included Excursions

3 UNESCO World Heritage Sites

19 Meals (including 1 Welcome Dinner and 1 Farewell Dinner)

DEPARTURES

March – November

Generations Collection available on select sailings.

OPTIONAL EXTENSIONS

Amsterdam (3-Day, pre/post-cruise)

Lake Lucerne (3-Day, pre/post-cruise)

Visit [Uniworld.com/Extensions](https://www.uniworld.com/Extensions) to learn more. Additional fees apply.

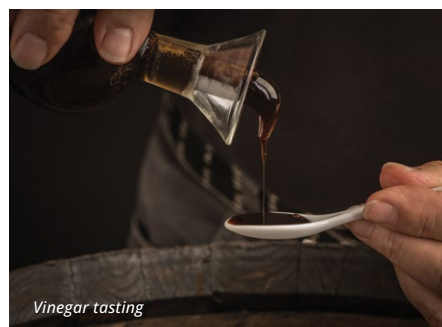

Scan code for detailed itinerary and excursions

[Uniworld.com/RhineCastles](https://www.uniworld.com/RhineCastles)

REMARKABLE RHINE & HISTORIC HOLLAND

11 Days • Amsterdam to Basel • S.S. Antoinette



This is a one-of-a-kind itinerary, overflowing with rich history and diverse culture. Cultural ties are a recurring theme on this cruise, and you'll have the chance to fully immerse yourself as you take part in local traditions, enjoy the regional cuisine, and get a deeper picture of how history has shaped and influenced this region for decades.

DAY 1
AMSTERDAM
Embark

DAY 2
AMSTERDAM
STRAAT Museum with Amsterdam canal cruise

DAY 3
HARLINGEN (LELYSTAD)
Harlingen Village Day

DAY 4
ARNHEM
Het Loo Palace visit

DAY 5
COLOGNE
Visit Cologne's Jewish Quarter

DAY 6
OBERWESEL
Let's Go Rheinfels Castle with tunnels

DAY 7
OBERWESEL, MAINZ
Idstein discovery tour or Wiesbaden walking tour

DAY 8
GERMERSHEIM
MTM Experience Private Doktorenhof Vinegar Estate visit and tasting

DAY 9
STRASBOURG
Strasbourg panoramic tour

DAY 10
BASEL
Nights Out Feldschlösschen brewery visit and tasting

DAY 11
BASEL
Disembark

UNIQUELY UNIWORLD

Glide along the main canals that crisscross the "Venice of the North" on an Amsterdam canal cruise.

Includes at least one **MTM Experience**.

MAKE TRAVEL MATTER
EXPERIENCE



WE SUPPORT THE SUSTAINABLE DEVELOPMENT GOALS

SNAPSHOT

- 10** Nights Cruising
- 23** Included Excursions
- 1** Private Experience
- 5** UNESCO World Heritage Sites
- 29** Meals (including 1 Welcome Dinner and 1 Farewell Dinner)

DEPARTURES

April - May, August - October

Jewish Heritage Program included on select sailings.

During major Jewish holidays, the Jewish Heritage excursions will not be offered.

OPTIONAL EXTENSION

Interlaken (3-Day, pre/post-cruise)

Visit [Uniworld.com/Extensions](https://www.uniworld.com/Extensions) to learn more. Additional fees apply.



Scan code for detailed itinerary information

[Uniworld.com/Rhine-Holland](https://www.uniworld.com/Rhine-Holland)

RHINE, MOSELLE & BELGIUM GRAND DISCOVERY

15 Days • Basel to Brussels • *S.S. Victoria*



Düsseldorf, Germany

Soak in as much of Central Europe's cities and culture as possible as you meander your way from Switzerland to Belgium, visiting six different countries along the way. Enjoy the fruits of Germany's excellent vineyards, step onto the streets of Antwerp for Golden Age art and Belgian treats, and breathe in the crisp mountain air of the Swiss Alps.

UNIQUELY UNIWORLD

Venture on a Cologne walking tour with Kölsch beer tasting.

Walk hundreds of feet above the treetops as you cross the suspension bridge of Geierlay.

Includes at least one **MTM Experience**.

MAKE TRAVEL MATTER
EXPERIENCE



WE SUPPORT THE SUSTAINABLE DEVELOPMENT GOALS

DAY 1

BASEL

Embark

DAY 2

BASEL (LUCERNE)

Delve into Basel, the "cultural capital of Switzerland"

DAY 3

STRASBOURG (BADEN-BADEN)

Discover Baden-Baden with a tour of the casino

DAY 4

MANNHEIM (SPEYER)

MTM Experience specialty vinegar apéritifs

DAY 5

RÜDESHEIM, BOPPARD

Visit a chocolatier in Rudesheim to sample their wares

DAY 6

BOPPARD, KOBLENZ

Let's Go bike Koblenz along the Rhine

DAY 7

BERNKASTEL

Sip on Rieslings at a prestigious Moselle Valley vineyard

DAY 8

SCHWEICH (TRIER/LUXEMBOURG)

Discover the remnants of Trier's ancient past

DAY 9

COCHEM

Visit the hilltop Reichsburg Castle for beautiful views

DAY 10

COLOGNE

Explore Cologne's storybook-worthy Old Town

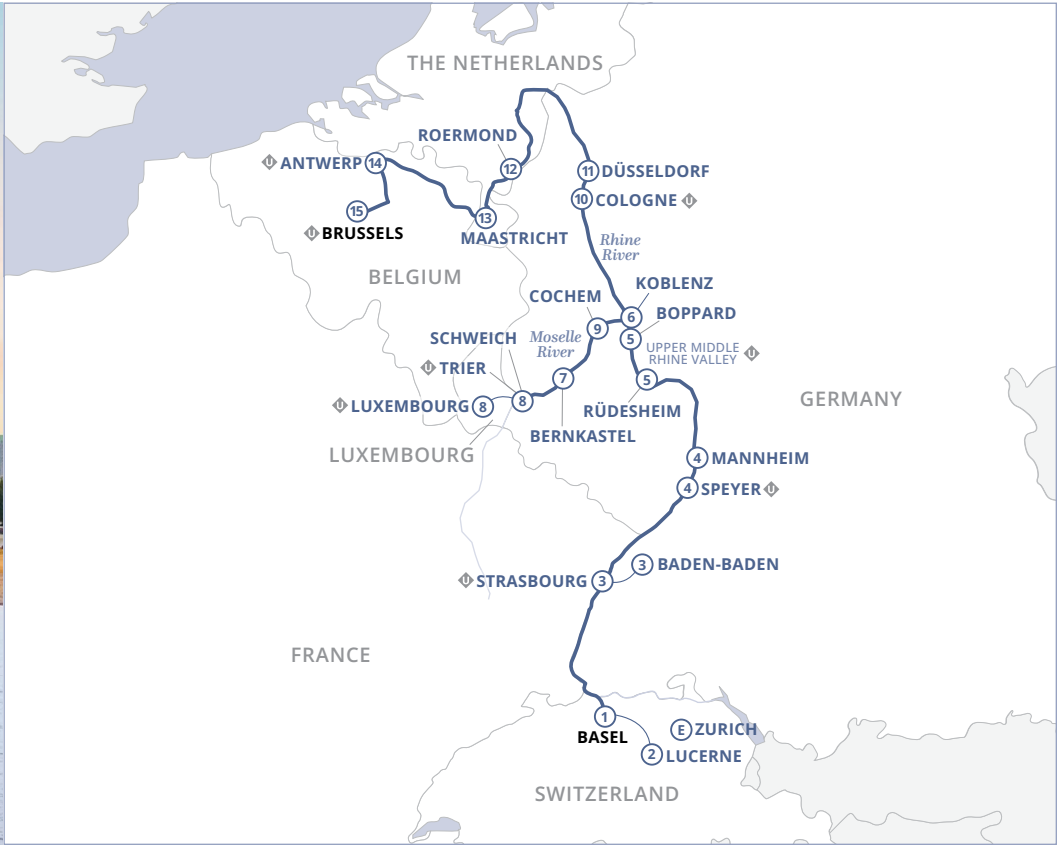

DAY 11

DÜSSELDORF

Take a stroll through town with a local guide

DAY 12

ROERMOND

Walking tour of Roermond

DAY 13

MAASTRICHT

Walking tour of Maastricht

DAY 14

ANTWERP

Antwerp walking tour with Belgian treats

DAY 15

BRUSSELS

Disembark

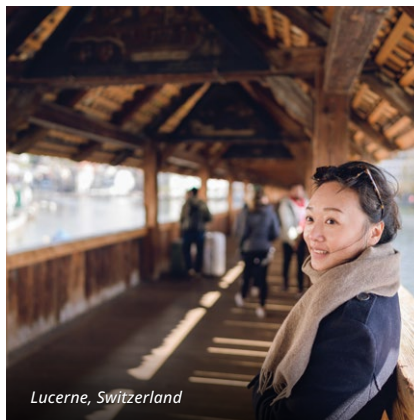

SNAPSHOT

14 Nights Cruising

29 Included Excursions

1 Private Experience

8 UNESCO World Heritage Sites

40 Meals (including 1 Welcome Dinner and 1 Farewell Dinner)

DEPARTURES

July – September

OPTIONAL EXTENSION

Zurich (3-Day, pre/post-cruise)

Visit Uniworld.com/Extensions to learn more. Additional fees apply.



Scan code for detailed itinerary information

Uniworld.com/RhineGrand

DELIGHTFUL DANUBE & PRAGUE (2025)

10 Days • Budapest to Prague • S.S. Beatrice



This cruise will immerse you in the great diversity of cultures along the Danube. Your time on the ship will give you a deeper appreciation for the regional cuisine. This is an enchanting voyage of history, music and art, showcasing imperial cities, Bavarian towns, and captivating natural landscapes.

DAY 1
BUDAPEST
Embark

DAY 2
BUDAPEST
Budapest panoramic highlights with Castle Hill and Matthias Church

DAY 3
VIENNA
Klimt at the Belvedere

DAY 4
SPITZ
Explore Stetteldorf Castle

DAY 5
ENGELHARTSZELL, PASSAU
Let's Go scenic Bavarian river biking

DAY 6
REGENSBURG
Nights Out Regensburg Cathedral Choir

DAY 7
NUREMBERG
Cruising the Main-Danube Canal

DAY 8
NUREMBERG, PRAGUE
Disembark and transfer to Prague

DAY 9
PRAGUE
Prague Old Town walking tour

DAY 10
PRAGUE
Return home

UNIQUELY UNIWORLD

Explore Jewish communities and sites with our **Jewish Heritage Program**.

Includes at least one **MTM Experience**.

MAKE TRAVEL MATTER
EXPERIENCE



WE SUPPORT THE SUSTAINABLE DEVELOPMENT GOALS

SNAPSHOT

- 7 Nights Cruising
- 2 Nights Touring
- 18 Included Excursions
- 5 UNESCO World Heritage Sites
- 22 Meals (including 1 Welcome Dinner and 1 Farewell Dinner)

DEPARTURES

April – October 2025

Jewish Heritage Program included on select sailings.

During major Jewish holidays, the Jewish Heritage excursions will not be offered.

CRUISE-ONLY OPTION

8 Days, Budapest to Nuremberg

OPTIONAL EXTENSION

Budapest (3-Day, pre/post-cruise)

Visit Uniworld.com/Extensions to learn more. Additional fees apply.



Hungarian chimney cakes



Scan code for detailed itinerary information

Uniworld.com/DelightfulDanube

DELIGHTFUL DANUBE & PRAGUE (2026)

10 Days • Budapest to Prague • S.S. Beatrice



Linz, Austria



Experience dynamic Budapest and imperial Vienna. Marvel at ravishing scenery as your luxurious ship glides through the Wachau Valley. This enchanting voyage provides a variety of ways to enjoy captivating destinations as well as plenty of time to relax onboard as you sail from Budapest to Regensburg, followed by two nights in Prague.

DAY 1
BUDAPEST
Embark

DAY 2
BUDAPEST
Budapest panoramic highlights with St. Stephen's Cathedral

DAY 3
VIENNA
Morning with the Masters at the Belvedere

DAY 4
DÜRNSTEIN
Dürnstein walking tour with Marillen tasting



Passau, Germany

DAY 5
LINZ
MTM Experience Linz walking tour with cider farm visit

DAY 6
ENGELHARTSZELL, PASSAU
Let's Go scenic Bavarian river biking

DAY 7
REGENSBURG
Nights Out Regensburg Cathedral Choir

DAY 8
REGENSBURG, PRAGUE
Disembark and transfer to Prague

DAY 9
PRAGUE
Prague Old Town walking tour

DAY 10
PRAGUE
Return home

UNIQUELY UNIWORLD

Explore Jewish communities and sites with our **Jewish Heritage Program**.

Includes at least one **MTM Experience**.

MAKE TRAVEL MATTER
EXPERIENCE



WE SUPPORT THE SUSTAINABLE DEVELOPMENT GOALS

SNAPSHOT

- 7 Nights Cruising
- 2 Nights Touring
- 18 Included Excursions
- 5 UNESCO World Heritage Sites
- 22 Meals (including 1 Welcome Dinner and 1 Farewell Dinner)

DEPARTURES

April - October 2026

Jewish Heritage Program included on select sailings.

During major Jewish holidays, the Jewish Heritage excursions will not be offered.

CRUISE-ONLY OPTION

8 Days, Budapest to Regensburg

OPTIONAL EXTENSION

Budapest (3-Day, pre/post-cruise)

Visit Uniworld.com/Extensions to learn more. Additional fees apply.



Scan code for detailed itinerary information

Uniworld.com/DelightfulDanube

ENCHANTING DANUBE

8 Days • Budapest to Passau • *S.S. Maria Theresa*



Melk Abbey, Melk, Austria



Journey through the lands that inspired many of history's most renowned musicians. Walk in their footsteps along the shores of the beautiful Danube, through breathtaking natural landscapes, charming riverside towns, and dazzling cities. Enjoy the land's rich musical culture through a private concert, and a visit to the Franz Liszt Academy of Music.

DAY 1
BUDAPEST
Embark

DAY 2
BUDAPEST
Walking tour with stops for local treats

DAY 3
BRATISLAVA, VIENNA
Nights Out Private Mozart and Strauss concert

DAY 4
VIENNA
Enjoy a crowd-free viewing of the Vienna Art History Museum's legendary art

DAY 5
DÜRNSTEIN, MELK
MTM Experience Dürnstein Wine Estate visit with tasting



Bratislava, Slovakia

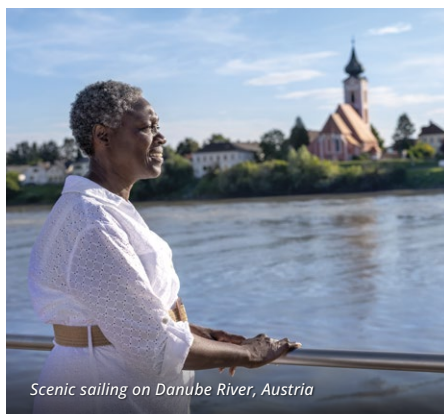

Scenic sailing on Danube River, Austria

DAY 6
LINZ (SALZBURG)
Full-day Salzburg with *Sound of Music*

DAY 7
PASSAU
Hike along the Ilz River for breathtaking views

DAY 8
PASSAU
Disembark (Munich airport)



Scan code for detailed itinerary information

Uniworld.com/EnchantingDanube

UNIQUELY UNIWORLD

Discover the spice as pure as gold at a saffron workshop in Dürnstein.

Includes at least one **MTM Experience**.

MAKE TRAVEL MATTER
EXPERIENCE



WE SUPPORT THE SUSTAINABLE DEVELOPMENT GOALS

SNAPSHOT

- 7 Nights Cruising
- 16 Included Excursions
- 1 Private Experience
- 4 UNESCO World Heritage Sites
- 20 Meals (including 1 Welcome Dinner and 1 Farewell Dinner)

DEPARTURES

April – October

Generations Collection available on select sailings.

Music of the Danube theme cruise available on select 2025 sailings.

OPTIONAL EXTENSIONS

- Athens & Santorini** (6-Day, post-cruise)
- Athens** (4-Day, post-cruise)
- Budapest** (3-Day, pre/post-cruise)
- Prague** (3-Day, pre/post-cruise)

Visit Uniworld.com/Extensions to learn more. Additional fees apply.

HIGHLIGHTS OF EASTERN EUROPE

10 Days • Budapest to Bucharest • *S.S. Beatrice, River Duchess, or River Princess*



This cruise follows the path forged by crusaders, kings, and conquerors through culturally rich and historically significant countries. Step back in time while we sail through the Iron Gates and visit the Royal Grounds of Karadjordjevic Dynasty Palace in Belgrade. Enjoy a Croatian lunch at a family restaurant, where you can mingle with a local family.

DAY 1
BUDAPEST
Embark

DAY 2
BUDAPEST
Budapest panoramic highlights
with synagogue visit

DAY 3
BATINA (OSIJEK), VUKOVAR
Vucedol Culture Museum and lunch
at a family restaurant

DAY 4
BELGRADE
Nights Out Kalemegdan Fortress concert

DAY 5
GOLUBAC, DONJI MILANOVAC
Lepenski Vir Archaeological Park
and Golubac Castle

DAY 6
VIDIN
Belogradchik Red Rock Valley

DAY 7
RUSE
Veliko Tarnovo and Arbanassi visit
with a Bulgarian lunch

DAY 8
GIURGIU, BUCHAREST
Disembark and transfer to Bucharest

DAY 9
BUCHAREST
Bucharest communist tour
with People's Palace visit

DAY 10
BUCHAREST
Return home



UNIQUELY UNIWORLD

Visit the Lepenski Vir Archaeological Park, one of the largest and most significant Stone Age sites.

Hike through the spectacular Belogradchik Red Rock Valley.

SNAPSHOT

7 Nights Cruising

2 Nights Touring

15 Included Excursions

2 UNESCO World Heritage Sites

22 Meals (including 1 Welcome Dinner
and 1 Farewell Dinner)

DEPARTURES

April - October

OPTIONAL EXTENSIONS

Budapest (3-Day, pre/post-cruise)

Transylvania 2026
(4-Day, pre/post-cruise)

Visit [Uniworld.com/Extensions](https://uniworld.com/Extensions) to learn more.
Additional fees apply.



Scan code for detailed
itinerary information

[Uniworld.com/EasternEurope](https://uniworld.com/EasternEurope)

EUROPEAN JEWELS

15 Days • Budapest to Amsterdam • *S.S. Beatrice, River Duchess, or River Princess*



Cologne, Germany

A deep dive into the cultural diversity of Central Europe, this cruise explores fascinating history, contrasting architecture, and distinct cuisines. Tour important WWII sites with an expert guide. Wander through fairytale Rothenburg and savor a taste of German sausage. This is an all-encompassing trip for travelers who want to see everything.

UNIQUELY UNIWORLD

Enjoy a Budapest walk with stops for sampling local treats.

Delight in a private visit to Vienna's House of Strauss, a museum and concert venue that offers a deep dive into the life and legacy of Johann Strauss II.

Walk up a cobblestone incline to Heidelberg Castle, with a guided tour of the courtyard and Heidelberg Tun.

Be treated to a Riesling tasting inside Abbey Eberbach Monastery.

DAY 1 BUDAPEST

Embark

DAY 2 BUDAPEST

Budapest panoramic highlights with Parliament visit

DAY 3 VIENNA

Nights Out House of Strauss visit and concert

DAY 4 VIENNA

Vienna-Imperial City highlights with Hofburg Palace visit

DAY 5 WEISSENKIRCHEN (MELK)

Weissenkirchen village walk with wine tasting

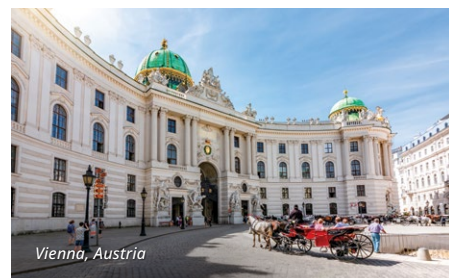

Vienna, Austria

DAY 6 PASSAU

Let's Go bike ride along the Inn River

DAY 7 REGENSBURG

"From Hops Field to Beer Stein" farm visit

DAY 8 NUREMBERG

Nuremberg city tour



DAY 9

BAMBERG

Franconian Village Day

DAY 10

WÜRZBURG (ROTHENBURG)

Würzburg Residence with Court Gardens visit

DAY 11

WERTHEIM

Let's Go scenic Wertheim bicycle tour

DAY 12

FRANKFURT (HEIDELBERG)

Heidelberg Castle visit

DAY 13

RÜDESHEIM

Abbey Eberbach Medieval Monastery

DAY 14

COLOGNE

Cologne walking tour

DAY 15

AMSTERDAM

Disembark



Amsterdam, the Netherlands



Hops farm, Regensburg, Germany

SNAPSHOT

14 Nights Cruising

27 Included Excursions

1 Private Experience

8 UNESCO World Heritage Sites

41 Meals (including 1 Welcome Dinner and 1 Farewell Dinner)

DEPARTURES

May - October

OPTIONAL EXTENSIONS

Budapest (3-Day, pre/post-cruise)

Amsterdam (3-Day, pre/post-cruise)

Visit Uniworld.com/Extensions to learn more. Additional fees apply.



Scan code for detailed itinerary information

Uniworld.com/EuropeanJewels

VIENNA & CAPITAL CITIES OF THE DANUBE

New for 2026

10 Days • Vienna to Belgrade • S.S. Emilie



The great Danube River, once the lifeblood of empires, has been home to Europe's greatest cities for eons. Join us on a journey spanning the four capital cities that sit along the banks of the Danube—glittering Vienna, charming Bratislava, eclectic Budapest, and storied Belgrade. In between, we'll contrast the buzz of city life with countryside views and a glimpse of rural life.

DAY 1 VIENNA

Arrive

DAY 2 VIENNA

Schönbrunn Palace visit

DAY 3 VIENNA

Embark

DAY 4 VIENNA

Imperial City highlights with Hofburg Palace visit

DAY 5 BRATISLAVA

Let's Go Hike to Bratislava Castle

DAY 6 BUDAPEST

Andrassy Avenue walking tour with Szabo Ervin Library

DAY 7 BATINA, ILOK

Vučedol Culture Museum and lunch at a family restaurant

DAY 8 NOVI SAD

Novi Sad walking tour

DAY 9 BELGRADE

Let's Go "I Bike Belgrade" tour

DAY 10 BELGRADE

Disembark

UNIQUELY UNIWORLD

Visit the Belvedere Palace after hours for a private viewing of the Klimt exhibit, arranged exclusively for Uniworld guests.

SNAPSHOT

7 Nights Cruising

2 Nights Touring

14 Included Excursions

2 UNESCO World Heritage Sites

22 Meals (including 1 Welcome Dinner and 1 Farewell Dinner)

DEPARTURES

May – November

CRUISE-ONLY OPTION

8 Days, Vienna to Belgrade

OPTIONAL EXTENSION

Dubrovnik (4-Day, pre/post-cruise)

Visit [Uniworld.com/Extensions](https://www.uniworld.com/Extensions) to learn more. Additional fees apply.



Scan code for detailed itinerary information

[Uniworld.com/CapitalCities](https://www.uniworld.com/CapitalCities)

VINEYARDS & PALACES ALONG THE DANUBE WITH PRAGUE

New for 2026

10 Days • Prague to Vienna • S.S. Emilie



Schönbrunn Palace, Vienna, Austria



Explore the viticultural and imperial legacy of the fabled Danube River, where dramatic hills rise from the riverbanks in stunning contrast to serene valleys and manicured vineyards. Head ashore to discover medieval villages, celebrated wineries, majestic palaces, and historic castles. This journey brings each of these elements together into one breathtaking river cruise.

DAY 1 PRAGUE

Arrive

DAY 2 PRAGUE

Prague Old Town and Charles Bridge walking tour

DAY 3 PRAGUE, NUREMBERG

Transfer to Nuremberg and embark

DAY 4 NUREMBERG

Nuremberg city walking tour

DAY 5 REGENSBURG

Regensburg walk with Thurn and Taxis Castle visit

DAY 6 STRAUBING, VILSHOFEN

Bavarian Forest adventure

DAY 7 PASSAU, ENGELHARTSZELL

Let's Go Hike along the Ilz

DAY 8 GREIN, SPITZ

Castle Clam visit

DAY 9 VIENNA

Visits to Schönbrunn Palace and Nights Out Klosterneuburg Winery

DAY 10 VIENNA

Disembark

UNIQUELY UNIWORLD

Walk a series of twisting paths to reach the top of Bavaria's famous wooden "adventure ball," the largest of its kind in the world.

Includes at least one **MTM Experience**.

MAKE TRAVEL MATTER
EXPERIENCE



WE SUPPORT THE SUSTAINABLE DEVELOPMENT GOALS

SNAPSHOT

7 Nights Cruising

2 Nights Touring

13 Included Excursions

4 UNESCO World Heritage Sites

21 Meals (including 1 Welcome Dinner and 1 Farewell Dinner)

DEPARTURES

May - November

CRUISE-ONLY OPTION

8 Days, Nuremberg to Vienna

OPTIONAL EXTENSION

Vienna (3-Day, pre/post-cruise)

Visit [Uniworld.com/Extensions](https://www.uniworld.com/Extensions) to learn more. Additional fees apply.



Vilshofen, Germany



Scan code for detailed itinerary information

[Uniworld.com/DanubePalaces](https://www.uniworld.com/DanubePalaces)

PARIS & NORMANDY

8 Days • Paris to Paris • S.S. *Joie de Vivre*

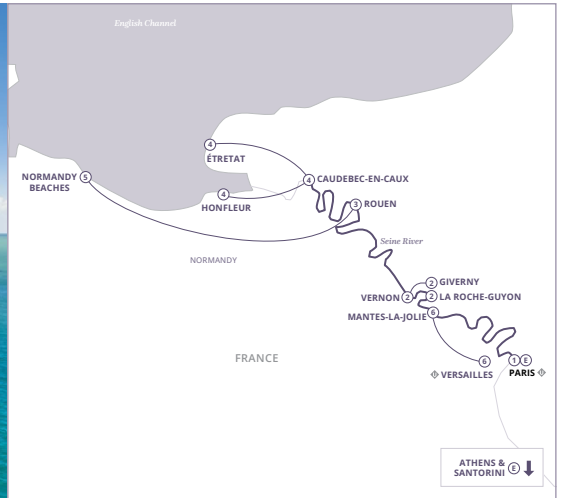

This cruise is designed for history buffs. Walk through the gardens that inspired so many of Monet's paintings in Giverny. Spend an entire day on the famous Normandy beaches and partake in a private ceremony. You'll experience the indulgent world of French royalty on a tour of Versailles and French joie de vivre as you follow a local around the much-loved neighborhoods of Paris.

DAY 1
PARIS
Embark

DAY 2
LA ROCHE-GUYON, VERNON, GIVERNY
Let's Go bike the countryside from Vernon to Monet's Giverny gardens

DAY 3
ROUEN
Nights Out private concert at Rouen Cathedral

DAY 4
CAUDEBEC-EN-CAUX (HONFLEUR)
Let's Go golf on the cliffs of the seaside village of Étretat

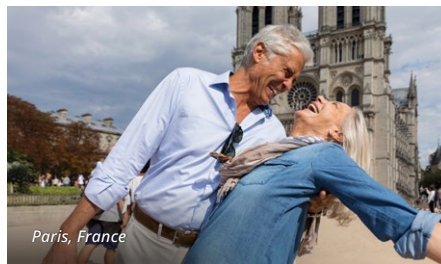

DAY 5
ROUEN (NORMANDY BEACHES)
Honor the heroes of D-Day at the Normandy beaches

DAY 6
MANTES-LA-JOLIE (VERSAILLES)
Explore the secret apartments of Versailles

DAY 7
PARIS
Paris walking tour of the Latin Quarter

DAY 8
PARIS
Disembark



UNIQUELY UNIWORLD

Tee off at the clifftop Golf d'Étretat, on a *Let's Go* experience.

Includes at least one **MTM Experience**.

MAKE TRAVEL MATTER
EXPERIENCE



WE SUPPORT THE SUSTAINABLE DEVELOPMENT GOALS

SNAPSHOT

- 7 Nights Cruising
- 15 Included Excursions
- 1 Private Experience
- 2 UNESCO World Heritage Sites
- 19 Meals (including 1 Welcome Dinner and 1 Farewell Dinner)

DEPARTURES

March - November

OPTIONAL EXTENSIONS

- Athens & Santorini** (6-Day, post-cruise)
- Athens** (4-Day, post-cruise)
- Paris** (3-Day, pre-cruise)

Visit [Uniworld.com/Extensions](https://www.uniworld.com/Extensions) to learn more. Additional fees apply.

CRUISE & RAIL OPTION

15 Days, Istanbul to Paris



Scan code for detailed itinerary information

[Uniworld.com/Paris-Normandy](https://www.uniworld.com/Paris-Normandy)

BURGUNDY & PROVENCE

8 Days • Arles to Lyon • S.S. Catherine



Experience the richness of French culture and cuisine as you sail through the heart of this famous wine region. Follow in the footsteps of Van Gogh on a walking tour of Arles. Learn about the gastronomic history of Lyon as you taste French specialties. This cruise will give you an authentic view of France, with visits to small villages to introduce you to the local way of life.

DAY 1

ARLES

Embark (transfer from Marseille airport)

DAY 2

ARLES

Stroll by medieval houses and ancient ruins in Arles

DAY 3

AVIGNON

Visit the impressive Palace of the Popes

DAY 4

VIVIERS

Ardèche Village Day

DAY 5

TAIN-L'HERMITAGE

Hike the terraced vineyards of Hermitage for a wine tasting



DAY 6

LYON

Take a Lyon panoramic tour with traboules visit

DAY 7

MÂCON (BEAUNE)

Browse the wares at the market outside colorful Hôtel-Dieu

DAY 8

LYON

Disembark



Scan code for detailed itinerary information

Uniworld.com/Burgundy-Provence

UNIQUELY UNIWORLD

Immerse yourself in nature and view an ancient Roman aqueduct from a unique angle when you kayak the Gardon River.

Includes at least one **MTM Experience**.

MAKE TRAVEL MATTER
EXPERIENCE



WE SUPPORT THE SUSTAINABLE DEVELOPMENT GOALS

SNAPSHOT

7 Nights Cruising

10 Included Excursions

5 UNESCO World Heritage Sites

19 Meals (including 1 Welcome Dinner and 1 Farewell Dinner)

DEPARTURES

March – November

Women-Only Cruise departs August 24, 2025.

OPTIONAL EXTENSIONS

Athens & Santorini (6-Day, post-cruise)

Athens (4-Day, post-cruise)

Mediterranean Cassis
(3-Day, pre/post-cruise)

Paris (3-Day, pre/post-cruise)

Visit Uniworld.com/Extensions to learn more. Additional fees apply.

BRILLIANT BORDEAUX

8 Days • Bordeaux to Bordeaux • S.S. *Bon Voyage*

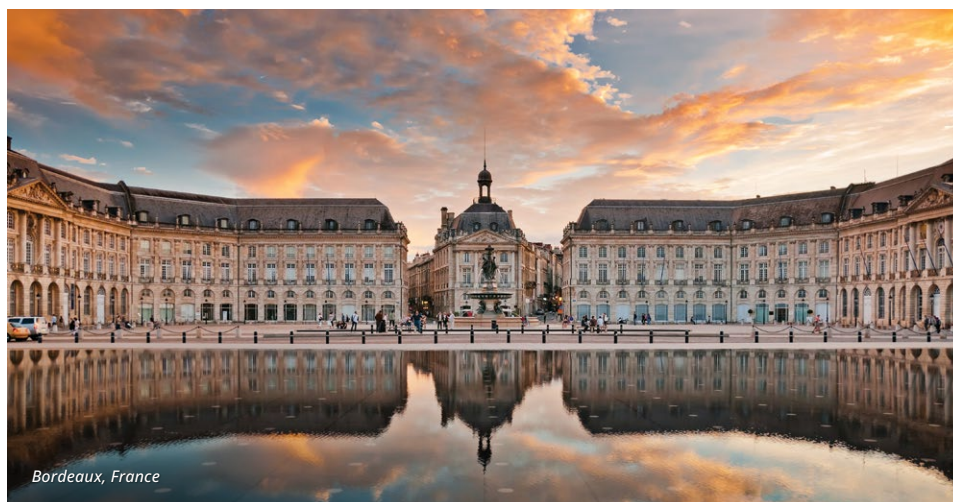

Bordeaux, France



There is no region in the world that is richer in cuisine, more abundant in wine, and more stunning in scenery than Bordeaux. If you want to experience the best kept secret in France, this is the cruise for you. For those who love wine, enjoy some of the best in the world at the critically acclaimed Grand Cru wineries. You'll feast on traditional French cuisine, from foie gras to oysters.

DAY 1
BORDEAUX
Embark

DAY 2
CUSSAC-FORT-MÉDOC, PAUILLAC
Private Experience Médoc Châteaux Route with wine tasting

DAY 3
CADILLAC, BORDEAUX
Private Experience Owner's tour of Royal Château with Sauternes toast

DAY 4
BLAYE
Panoramas of Route de la Corniche Fleurie with Blaye Fortress

DAY 5
LIBOURNE (SAINT-ÉMILION)
Saint-Émilion walking tour with wine tasting

DAY 6
LIBOURNE, BORDEAUX
Nights Out after-hours at Bassins des Lumières

DAY 7
BORDEAUX
Let's Go bike through the backstreets of Bordeaux, stopping to try out local treats

DAY 8
BORDEAUX
Disembark

UNIQUELY UNIWORLD

Delight in an optional *Masterpiece Collection* cooking lesson and lunch at Château Ambe Tour Pourret.

Venture on a *Nights Out* after-hours visit to Bassins des Lumières in Bordeaux.

SNAPSHOT

- 7 Nights Cruising
- 12 Included Excursions
- 3 UNESCO World Heritage Sites
- 19 Meals (including 1 Welcome Dinner and 1 Farewell Dinner)

DEPARTURES

March - October

Premium Golf Package available on select 2025 sailings.

OPTIONAL EXTENSIONS

Biarritz Basque Country
(4-Day, pre-cruise)

Paris (3-Day, post-cruise)

Visit [Uniworld.com/Extensions](https://uniworld.com/Extensions) to learn more. Additional fees apply.



Château wine tasting



Blaye, France



Scan code for detailed itinerary and excursions

[Uniworld.com/BrilliantBordeaux](https://uniworld.com/BrilliantBordeaux)

PORTUGAL, SPAIN & THE DOURO RIVER VALLEY

11 Days • Porto to Lisbon • S.S. *São Gabriel*



Douro Valley, Portugal



Superb cuisine, fine wines, and excellent hospitality come together in Europe's best-kept secret, the Douro River Valley. Relaxing in the sun deck pool of the S.S. *São Gabriel*, you'll marvel at the terraced hillsides and dramatic landscapes that produce the region's incredible olives, almonds, and wines. Onshore, you'll enjoy tasty local treats and discover the region's love for beauty.

DAY 1
PORTO, ENTRE-OS-RIOS
Embark

DAY 2
RÉGUA, PINHÃO
Enjoy a local quinta guided tour with tasting

DAY 3
POCINHO (CASTELO RODRIGO), VEGA DE TERRÓN
See the prehistoric carvings of the Côa Valley Archaeological Park

DAY 4
VEGA DE TERRÓN (SALAMANCA), BARCA D'ALVA
Visit Salamanca, home of Spain's oldest university



Belem Tower, Lisbon, Portugal

DAY 5
RÉGUA
Nights Out dinner at a local quinta

DAY 6
PORTO (BRAGA)
Braga city tour

DAY 7
PORTO, CALDAS DE AREGOS
Do as the Locals Do walking exploration of Porto

DAY 8
PORTO, LISBON
Disembark and transfer to Lisbon

DAY 9
LISBON
Take a walking tour through the city

DAY 10
LISBON
Today you have a full day at leisure

DAY 11
LISBON
Return home

UNIQUELY UNIWORLD

Immerse yourself in nature and view an ancient Roman aqueduct from a unique angle when you kayak the Gardon River.

SNAPSHOT

- 7 Nights Cruising
- 3 Nights Touring
- 12 Included Excursions
- 4 UNESCO World Heritage Sites
- 22 Meals (including 1 Welcome Dinner and 1 Farewell Dinner)

DEPARTURES

April – November

CRUISE-ONLY OPTION

8 Days, Porto to Porto

OPTIONAL EXTENSION

Madeira Island (4-Day, pre-cruise/tour)

Visit [Uniworld.com/Extensions](https://www.uniworld.com/Extensions) to learn more. Additional fees apply.



Scan code for detailed itinerary information

[Uniworld.com/DouroRiverValley](https://www.uniworld.com/DouroRiverValley)

WINE ROADS OF FRANCE & PORTUGAL

18 Days • Bordeaux to Lisbon • S.S. *Bon Voyage* & S.S. *São Gabriel*



Saint-Émilion, France

Combine two of Europe's most spectacular viticultural regions in one trip on this ultimate itinerary for wine lovers. The Southern European climates and historic towns of both Bordeaux and Portugal are as complementary as their palettes—expect bold reds and excellent dessert wines, from Sauternes to Port.

UNIQUELY UNIWORLD

Browse the tantalizing wares of the famous farmers market in Libourne, then meet some of the local artisans who contribute to the market.

Tour the ancient rock art of the Côa Valley, some dating back to the Paleolithic period.

Enter a little wine bar in Blaye for an intimate tasting led by the owner, who is also an avid collector of wine, art, and antique cars.

Sample some of France's best wines during a private tasting at a château on the Médoc route.

DAY 1
BORDEAUX
Embark

DAY 2
CUSSAC-FORT-MÉDOC, PAUILLAC
Private Experience Médoc Châteaux Route with wine tasting

DAY 3
CADILLAC, BORDEAUX
Private Experience Owner's tour of Royal Château with Sauternes toast

DAY 4
BLAYE
Panoramas of Route de la Corniche Fleurie with Blaye Fortress

DAY 5
LIBOURNE (SAINT-ÉMILION)
Saint-Émilion walking tour with wine tasting

DAY 6
LIBOURNE, BORDEAUX
Nights Out after-hours at Bassins des Lumières

DAY 7
BORDEAUX
Let's Go bike through the backstreets of Bordeaux, stopping to try out local treats

DAY 8
BORDEAUX, PORTO, ENTRE-OS-RIOS
Disembark and fly to Porto, embark ship

DAY 9
RÉGUA, PINHÃO
Enjoy a local quinta guided tour with tasting

DAY 10
POCINHO (CASTELO RODRIGO), VEGA DE TERRÓN
Côa Valley Archaeological Park



DAY 11
VEGA DE TERRÓN (SALAMANCA),
BARCA D'ALVA

Salamanca visit

DAY 12
RÉGUA

Nights Out dinner at a local quinta

DAY 13
PORTO (BRAGA)

Braga city tour

DAY 14
PORTO, CALDAS DE AREGOS

Porto panoramic tour

DAY 15
PORTO, LISBON

Disembark and transfer to Lisbon

DAY 16
LISBON

Take a walking tour through the city

DAY 17
LISBON

Full day at leisure to explore

DAY 18
LISBON

Return home

SNAPSHOT

14 Nights Cruising

3 Nights Touring

24 Included Excursions

2 Private Experiences

8 UNESCO World Heritage Sites

41 Meals (including 1 Welcome Dinner and 1 Farewell Dinner)

DEPARTURES

April – October

GRAND ITINERARY

This grand itinerary is a combination of **Brilliant Bordeaux** and **Portugal, Spain & the Douro River Valley**.

OPTIONAL EXTENSION

Biarritz Basque Country (4-Day, pre-cruise)

Visit Uniworld.com/Extensions to learn more. Additional fees apply.



Port wine and pastel de nata



Scan code for detailed itinerary information

Uniworld.com/France-Portugal

MILAN, VENICE & THE JEWELS OF VENETO

10 Days • Milan to Venice • S.S. *La Venezia*



Duomo Square, Milan, Italy

Northern Italy's Veneto region will delight all of your senses. Enjoy early access to the famed Doge's Palace in Venice, soak in the serenity of the fishing town of Chioggia and take a stroll in fair Verona. You have the unique opportunity to see the non-tourist side of Burano as you learn about the daily life of locals.

UNIQUELY UNIWORLD

Explore Doge's Palace in total peace with exclusive early access.

Experience a *Nights Out* private, after-hours visit inside St. Mark's Basilica.

Join a *Masterpiece Collection* optional excursion to Lake Como and Bellagio.

Set off for the Euganean hills to discover one of Europe's most majestic castles, Castello del Catajo.

Includes at least one **MTM Experience**.

MAKE TRAVEL MATTER
EXPERIENCE



WE SUPPORT THE SUSTAINABLE DEVELOPMENT GOALS

DAY 1

MILAN

Arrive

DAY 2

MILAN

Milan highlights city tour, including viewing of Da Vinci's *The Last Supper*

DAY 3

MILAN (VERONA & VALPOLICELLA), VENICE

En route to the ship in Venice, enjoy lunch with a sampling of Amarone wines

DAY 4

VENICE (RIVA DEI SETTE MARTIRI, SAN BASILIO)

A walk in Venice with Doge's Palace visit

DAY 5

VENICE (PADUA), MAZZORBO (BURANO)

Padua walking tour or Vicenza with Teatro Olimpico

DAY 6

MAZZORBO (BURANO), CHIOGGIA

Murano glass blowing demonstration

DAY 7

CHIOGGIA

Let's Go Biking Chioggia

DAY 8

CHIOGGIA, VENICE (SAN BASILIO)

Relax with a lagoon sailing into Venice

DAY 9

VENICE (SAN BASILIO)

Enjoy a full day in Venice with several options to immerse yourself in local culture

DAY 10

VENICE (SAN BASILIO)

Disembark



Venice, Italy



Chioggia, Italy



Murano blown glass



Scan code for detailed itinerary information

Uniworld.com/Veneto

SNAPSHOT

- 7** Nights Cruising
- 2** Nights Touring
- 19** Included Excursions
- 1** Private Experience
- 3** UNESCO World Heritage Sites
- 22** Meals (including 1 Welcome Dinner and 1 Farewell Dinner)

DEPARTURES

March - October 2025

CRUISE-ONLY OPTION

8 Days, Venice to Venice

CRUISE & RAIL OPTIONS

- 19 Days, Milan to Istanbul
- 17 Days, Venice to Istanbul
- 16 Days, Budapest to Venice

See page 60 to learn more.

OPTIONAL EXTENSIONS

- Athens & Santorini** (6-Day, post-cruise)
- Athens** (4-Day, post-cruise)
- Lugano & Lake Como** (3-Day, pre-cruise)

Visit Uniworld.com/Extensions to learn more. Additional fees apply.

GRANDE ITALIA

13 Days • Milan to Rome • S.S. *La Venezia*



Piazza de Spagna, Rome, Italy

Find yourself enchanted by three of Italy's most exciting cities as you embark on a series of immersive experiences. Begin your adventure in lively Milan. Then embark on your cruise through Venice and Northern Italy. Complete your spectacular Italian adventure with a stay in Rome, where a local guide will whisk you away to the most charming and historic sites.

UNIQUELY UNIWORLD

In Milan, view Leonardo da Vinci's famous painting, *The Last Supper*.

Wander the streets of fair Verona, the home of William Shakespeare's *Romeo & Juliet*.

Spend three nights in Rome to soak in the local sights and culture.

Enter Vatican City, where you'll marvel at the extravagant frescoes of the Sistine Chapel and see St. Peter's Basilica, the largest church ever built.*

*At times, access to the Vatican is not available; in those circumstances, we will visit the Colosseum.

DAY 1

MILAN

Arrive

DAY 2

MILAN

Marvel at the jaw-dropping facades of Il Duomo

DAY 3

MILAN (VERONA & VALPOLICELLA), VENICE

En route to embark the ship in Venice, enjoy lunch accompanied by a sampling of rare Amarone wines

DAY 4

VENICE (RIVA DEI SETTE MARTIRI, SAN BASILIO)

Doge's Palace visit in the morning and *Nights Out* private after-hours visit of St. Mark's Basilica

DAY 5

VENICE (PADUA), MAZZORBO (BURANO)

Padua walking tour or Vicenza with Teatro Olimpico, then take an evening stroll through colorful Burano

DAY 6

MAZZORBO (BURANO), CHIOGGIA

Discover the mosaic tucked away in the nearly abandoned island of Torcello

DAY 7

CHIOGGIA

Let's Go Biking Chioggia

DAY 8

CHIOGGIA, VENICE (SAN BASILIO)

Relax with a lagoon sailing into Venice

DAY 9

VENICE (SAN BASILIO)

Enjoy a full day in Venice

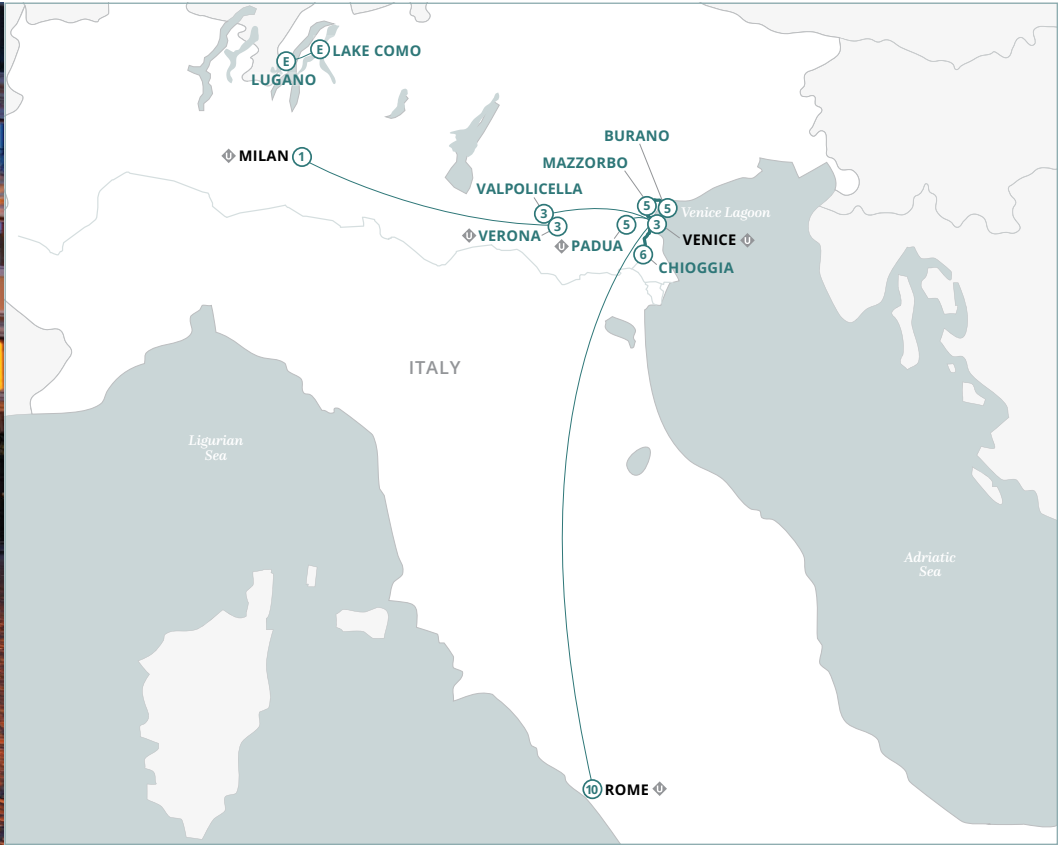

DAY 10

VENICE, ROME

Disembark the ship and transfer to Rome

DAY 11

ROME

Take a panoramic tour of Rome

DAY 12

ROME

Visit the Vatican, Sistine Chapel, and St. Peter's Basilica*

DAY 13

ROME

Return home



Sistine Chapel, Vatican City

SNAPSHOT

7 Nights Cruising

5 Nights Touring

22 Included Excursions

1 Private Experience

4 UNESCO World Heritage Sites

25 Meals (including 1 Welcome Dinner and 1 Farewell Dinner)

DEPARTURES

March – October 2025

WITHOUT MILAN OPTION

11 Days, Venice to Rome

OPTIONAL EXTENSION

Lugano & Lake Como (3-Day, pre-cruise)

Visit Uniworld.com/Extensions to learn more. Additional fees apply.



Burano, Italy



Scan code for detailed itinerary information

Uniworld.com/GrandItalia



EXTRAORDINARY

*Fill your bucket with
once-in-a-lifetime journeys*



Ganges River, Kolkata, India

MARAÑÓN: Peru

UCAYALI: Peru

MEKONG: Cambodia, Vietnam

GANGES: India

NILE: Egypt

PERUVIAN AMAZON & MACHU PICCHU EXPLORATION

16 Days • Lima to Lima • *Aria Amazon*



Machu Picchu, Peru

See the very best of Peru on this all-encompassing adventure. As you make your way into the Peruvian rainforest, you'll be surrounded by diverse flora and lush greenery. Enjoy the vibrant flavors of Peruvian cuisine prepared by local chefs using regional ingredients. Experience the overwhelming beauty of the Sacred Valley and Machu Picchu up close.

UNIQUELY UNIWORLD

Indulgent and immersive, our hotel stays include the beautiful **Country Club Lima Hotel** and two Luxury Collection Hotels: the **Tambo del Inka** of the Sacred Valley and the historic **Palacio del Inka**, housed within a 500-year-old mansion in Cusco.

Explore the heartland of the Incan Empire with a trip to Cusco.

Revel in the marvels of Machu Picchu, the Lost City of the Incas.

Kayak, canoe, and swim in the waters of the Peruvian Amazon.

DAY 1

LIMA

Arrive

DAY 2

LIMA

Lunch with a local family at Casa Aliaga

DAY 3

LIMA, IQUITOS (NAUTA)

Fly to Iquitos and embark the ship

DAY 4

UCAYALI RIVER, CLAVERO LAKE, YARAPA RIVER

Meet the locals of a remote village

DAY 5

AMAZON RIVER, TAHUAYO RIVER, SAN PEDRO FOREST

Trek the San Pedro Forest

DAY 6

NAUTA, MARAÑÓN RIVER

Discover exotic fruits at a local market

DAY 7

MARAÑÓN RIVER, YANAYACU PUCATE RIVER, AMAZON RIVER

Partake in a nocturnal wildlife exploration along the Amazon River

DAY 8

SAMIRIA RIVER, UCAYALI RIVER

Pacaya-Samiria National Reserve

DAY 9

AMAZON RIVER

Puerto Prado Village visit

DAY 10

NAUTA (IQUITOS), CUSCO, SACRED VALLEY

Disembark and fly to Cusco

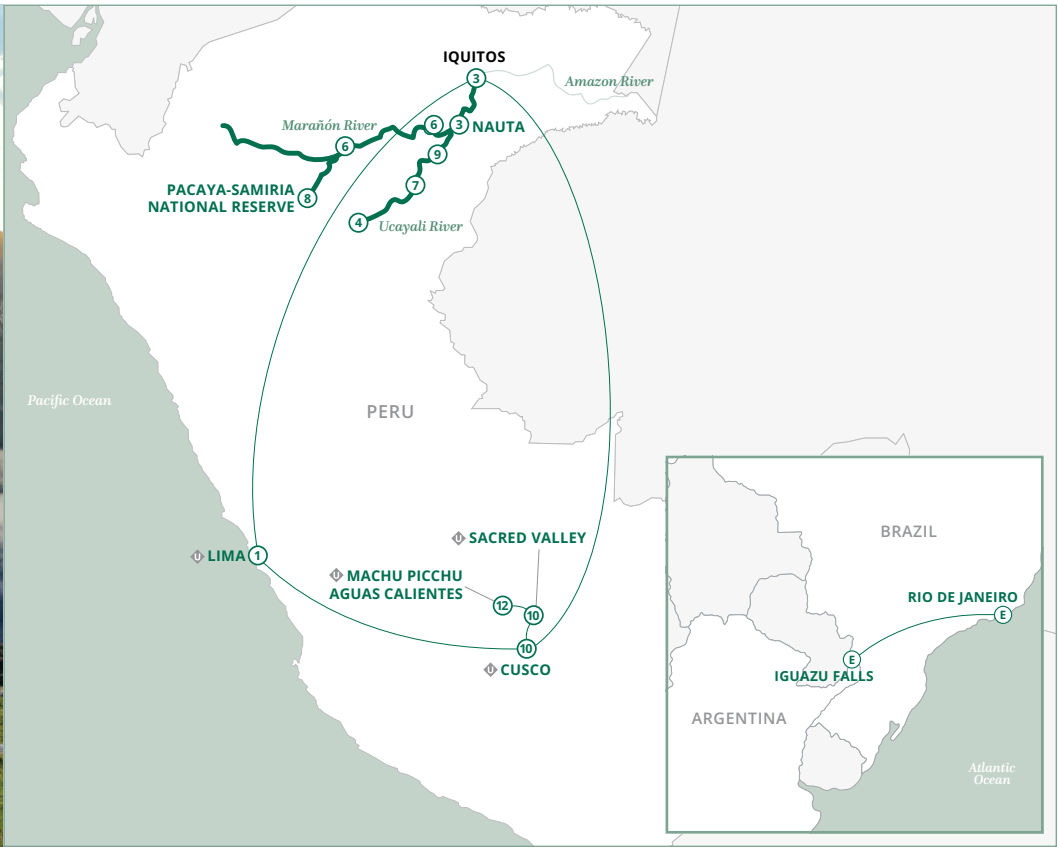

DAY 11

SACRED VALLEY

Enjoy a day at leisure

DAY 12

SACRED VALLEY, AGUAS CALIENTES (MACHU PICCHU)

Picnic in the Sacred Valley, followed by a train ride to Aguas Calientes

DAY 13

MACHU PICCHU, CUSCO

Tour Machu Picchu

DAY 14

CUSCO

Dine at the San Francisco Monastery

DAY 15

CUSCO, LIMA

San Blas walking tour and flight to Lima

DAY 16

LIMA

Return home



Amazon bird watching



Cusco, Peru



Scan code for detailed itinerary information

Uniworld.com/Peruvian-Exploration

SNAPSHOT

7 Nights Cruising

8 Nights Touring

28 Included Excursions

4 UNESCO World Heritage Sites

36 Meals (including 1 Welcome Dinner and 1 Farewell Dinner)

DEPARTURES

January, March – December

OPTIONAL EXTENSION

Rio de Janeiro & Iguazu Falls

(5-Day, pre-cruise/tour)

Visit Uniworld.com/Extensions to learn more. Additional fees apply.

PERUVIAN RIVERS & RAINFOREST DISCOVERY

11 Days, Lima to Lima

Discover Lima and the Peruvian rainforest on an alternate itinerary, where you'll take a jungle walk across the Amazon.

Visit Uniworld.com/Peruvian-Discovery to learn more.

TIMELESS WONDERS OF VIETNAM, CAMBODIA & THE MEKONG

15 Days • Ho Chi Minh City to Hanoi • *Mekong Jewel*



Angkor Thom, Siem Reap, Cambodia

Welcoming locals and colorful buildings make for an unforgettable journey that links a complex history with a powerful future. Vietnam and Cambodia are two countries rich in stories and overflowing in breathtaking sights. This cruise will take you to the famous temples of Angkor Wat and the bustling city of Ho Chi Minh, along with smaller villages in between.

UNIQUELY UNIWORLD

We've handpicked the finest hotels for every land stay, including the incredible **Park Hyatt Saigon** and a pair of beautiful **Sofitel** properties in Hanoi and Siem Reap.

Try your hand at making rice paper chips during a visit to a family-owned rice workshop.

Explore local communities with a Khmer Rouge survivor.

DAY 1
HO CHI MINH CITY
Arrive

DAY 2
HO CHI MINH CITY
Enjoy a panoramic city tour

DAY 3
HO CHI MINH CITY, MY THO, TIEN LOI
Tour the Cú Chi Tunnels, embark the ship

DAY 4
TIEN LOI ISLAND, VINH LONG, SA DEC
Venture to the untouched island of Tien Loi

DAY 5
SA DEC, GIENG ISLAND
Visit the colorful Huynh Thuy Le House

DAY 6
HONG NGU VILLAGE, PHNOM PENH
Visit a Khmer scarves weaving family, Hoa Ha Temple, and visit a local family

DAY 7
PHNOM PENH
Tour around town and visit Royal Palace via tuk tuk

DAY 8
PHNOM PENH
Learn about the infamous Khmer Rouge Killing Fields

DAY 9
ANGKOR BAN, WAT HANCHEY, KAMPONG CHAM
Experience Cambodia's vibrant cultural life



DAY 10

KAMPONG CHAM, SIEM REAP

Disembark the ship and tour Siem Reap

DAY 11

SIEM REAP

Explore the temples of Angkor Wat

DAY 12

SIEM REAP

Enjoy a traditional Apsara dance show

DAY 13

SIEM REAP, HANOI

Free time in Siem Reap before your flight to Hanoi

DAY 14

HANOI

Explore Hanoi with a city tour

DAY 15

HANOI

Return home



SNAPSHOT

7 Nights Cruising

7 Nights Touring

13 Included Excursions

2 UNESCO World Heritage Sites

32 Meals (including 1 Welcome Dinner and 1 Farewell Dinner)

DEPARTURES

January - March, September - December

OPTIONAL EXTENSION

Ha Long Bay (4-Day, pre/post-cruise/tour)

Visit Uniworld.com/Extensions to learn more. Additional fees apply.



Scan code for detailed itinerary information

Uniworld.com/TimelessWonders

INDIA'S GOLDEN TRIANGLE & THE SACRED GANGES

13 Days • New Delhi to Kolkata • *Ganges Voyager II*



Taj Mahal, Agra, India

Rich in color and flavor, a trip through India will leave you forever transformed, from the sprawling capital city of New Delhi to the artisan village of Matiari. Seeing the Taj Mahal—once at sunrise and once at sunset. Partake in demonstrations of traditional henna and regional spices. This cruise highlights the diverse architecture, cuisine and ways of life at every destination.

UNIQUELY UNIWORLD

Start your trip with five luxurious nights at three different **Oberoi Hotels**.

Experience a variety of onboard yoga classes and meditation sessions, as part of our **Wellness Program**.

Includes at least one **MTM Experience**.

MAKE TRAVEL MATTER
EXPERIENCE



WE SUPPORT THE SUSTAINABLE DEVELOPMENT GOALS

DAY 1
NEW DELHI
Arrive

DAY 2
NEW DELHI
New Delhi city tour on rickshaw ride to Old Delhi

DAY 3
NEW DELHI, AGRA
Visit the Taj Mahal in the afternoon and stay for sunset

DAY 4
AGRA, JAIPUR
Taj Mahal at sunrise

DAY 5
JAIPUR
Amber Fort and City Palace complex

DAY 6
JAIPUR, KOLKATA, KALNA
Fly to Kolkata and embark the ship

DAY 7
KALNA, MATIARI
MTM Experience India's "Temple City"

DAY 8
MATIARI, MURSHIDABAD
MTM Experience Matiari Master Craftsmen with an introduction to brass

DAY 9
MURSHIDABAD, BARANAGAR
Buggy ride to Katra Mosque; Baranagar village

DAY 10
KHUSBAGH, MAYAPUR
Khusbagh walk with a visit to see the mausoleum and arcade verandah

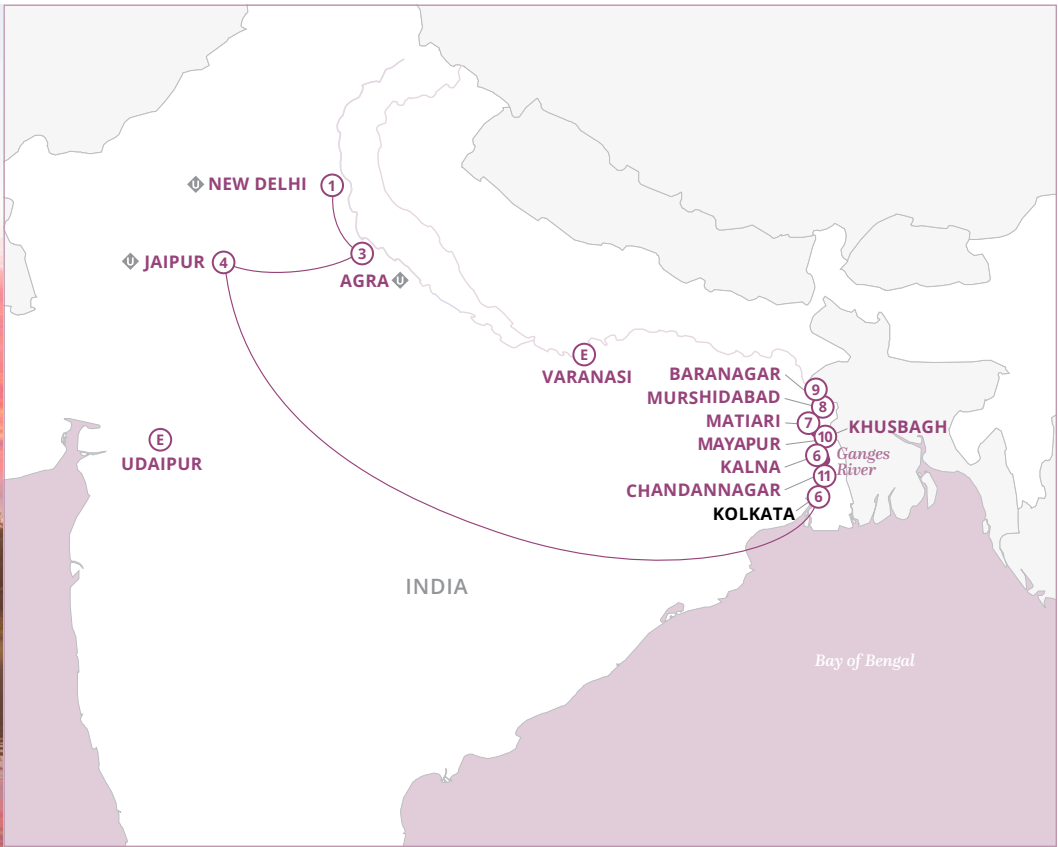

DAY 11

MAYAPUR, CHANDANNAGAR, KOLKATA

Hare Krishna complex and Temple of the Vedic Planetarium

DAY 12

KOLKATA

Choice of *MTM Experience* NGO "Calcutta Rescue" or *MTM Experience* Mother Teresa's home and tomb

DAY 13

KOLKATA

Disembark



Humayun's Tomb, New Delhi, India



The Oberoi Rajvilas, Jaipur, India



Scan code for detailed itinerary information

Uniworld.com/GoldenTriangle

SNAPSHOT

7 Nights Cruising

5 Nights Touring

15 Included Excursions

4 UNESCO World Heritage Sites

31 Meals (including 1 Welcome Dinner and 1 Farewell Dinner)

DEPARTURES

January - March, September - December

Wellness Program included on all sailings.

OPTIONAL EXTENSIONS

Udaipur (4-Day, pre-cruise/tour)

Varanasi (3-Day, post-cruise/tour)

Visit Uniworld.com/Extensions to learn more. Additional fees apply.

CRUISE & RAIL OPTION

16 Days, Kolkata to Mumbai or New Delhi (2025)

See page 60 to learn more.

SPLENDORS OF EGYPT & THE NILE

12 Days • Cairo to Cairo • *S.S. Sphinx* or *River Tosca*



Let an expert Egyptologist be your guide during this deep exploration of one of the most richly historic countries in the world. You'll be awestruck as you gaze at the Temples of Karnak and Hathor, the Great Sphinx and the Giza Pyramids. Cruise down the Nile, following the paths of Queens and Pharaohs. Marvels, myths, and wonders combine a once-in-a-lifetime experience.

UNIQUELY UNIWORLD

For the ultimate combination of style and location, we've reserved the **Four Seasons Hotel Cairo at Nile Plaza** and **The Nile Ritz-Carlton** for our guests in Cairo.

Choose from the most luxurious ships on the Nile: the stunning *S.S. Sphinx* or the all-suite *River Tosca*.

Explore with your local guide, a trained Egyptologist.

Take a dip in the swimming pool or lounge in any number of shaded cabanas on the sun deck.

DAY 1

CAIRO

Arrive

DAY 2

CAIRO

Visit the intricately decorated Alabaster Mosque

DAY 3

CAIRO, LUXOR, DENDERA

Fly to Luxor and embark the ship

DAY 4

DENDERA, LUXOR

View the blue zodiac ceiling at the Temple of Hathor

DAY 5

LUXOR, KOM OMBO

Learn about the myths carved into the walls of the Valley of the Kings

DAY 6

KOM OMBO, ASWAN

Keep an eye out for herons and sunbirds on a boat ride

DAY 7

ASWAN

Drink tea at the Old Cataract Hotel which inspired Agatha Christie's *Death on the Nile*

DAY 8

ASWAN

Masterpiece Collection optional experience to the Temples of Abu Simbel

DAY 9

ESNA, LUXOR

Find the last known Egyptian hieroglyphs ever recorded



DAY 10

LUXOR, CAIRO

Disembark for your flight back to Cairo

DAY 11

CAIRO

Admire the Great Sphinx and the Pyramids of Giza

DAY 12

CAIRO

Return home



Great Sphinx, Giza, Egypt

SNAPSHOT

7 Nights Cruising

4 Nights Touring

11 Included Excursions

12 UNESCO World Heritage Sites

26 Meals

DEPARTURES

January – May, September – December

Generations Collection included on select sailings.

OPTIONAL EXTENSIONS

Jordan (6-Day, pre-cruise/tour)

The Red Sea (5-Day, post-cruise/tour)

Visit Uniworld.com/Extensions to learn more. Additional fees apply.



Valley of the Kings, Luxor, Egypt



Scan code for detailed itinerary information

Uniworld.com/SplendorsOfEgypt

HOLIDAY SEASON

It's the most wonderful cruise of the year

A festive voyage during the holiday season calls for glittering tree-lined avenues, decadent seasonal treats, idyllic winter backdrops and other once-a-year delights. Peruse centuries-old Christmas markets with a cup of mulled wine or a locally brewed beer, while taking in the sights and sounds of an old-world holiday. It's one of the most memorable ways to celebrate the season.

DUTCH & BELGIAN HOLIDAY CELEBRATION *(New Itinerary)*

11 Days • Brussels to Amsterdam • *S.S. Victoria*

December departure

BELGIAN HOLIDAY MARKETS

8 Days • Brussels to Brussels • *S.S. Victoria*

November & December departures

CLASSIC CHRISTMAS MARKETS

8 Days • Nuremberg to Frankfurt • *S.S. Elisabeth*, *S.S. Emilie*, or *River Duchess*

November & December departures

RHINE HOLIDAY MARKETS

8 Days • Basel to Cologne • *S.S. Antoinette* or *S.S. Elisabeth*

November & December departures

EUROPEAN HOLIDAY MARKETS

8 Days • Nuremberg to Vienna • *S.S. Beatrice* or *S.S. Emilie*

December departures

DANUBE HOLIDAY MARKETS

8 Days • Budapest to Passau • *S.S. Maria Theresa* or *River Princess*

December departures

ENCHANTING CHRISTMAS & NEW YEAR'S

11 Days • Passau to Budapest • *S.S. Maria Theresa*

December departure

GRAND CHRISTMAS & NEW YEAR'S

13 Days • Nuremberg to Budapest • *S.S. Beatrice* or *S.S. Emilie*

December departure



Scan code for detailed
itineraries information

Uniworld.com/Holiday



Christmas market, Frankfurt, Germany



Rothenburg, Germany



Vienna, Austria



Amsterdam, the Netherlands

CRUISE & RAIL

The ultimate luxury travel combination

We've partnered with two different five-star luxury train brands to craft extraordinary journeys of river cruising, land and train travel. As a pre- or post-cruise addition to your time sailing in all-inclusive luxury with Uniworld, you'll embark on one of the best private train experiences the world has to offer.



Scenic train ride aboard the Golden Eagle Danube Express



THE PERFECT PAIRING

Everchanging views, visiting a variety of destinations in one trip without having to pack up every time and having everything taken care of for you—all benefits of river cruising, and all reasons to love train travel too.



OUR LUXURY RAIL PARTNERS

We're thrilled to partner with **Golden Eagle** and the **Maharajas' Express** for *Cruise & Rail* journeys that bring the Uniworld standard of luxury to the private train experience. And of course, it's all-inclusive.



ACCOMMODATIONS

Pair your boutique floating hotel with a luxurious gliding hotel, where your en-suite cabin is an elegant private compartment during the day and transforms into a comfortable bedroom for the evening.



SERVICE

Both of our luxury rail partners promise first-class service for an exciting and stress-free journey. You'll also enjoy the services of a dedicated Tour Manager just for Uniworld guests and expert guides on excursions.



DINING

Feast on delicious cuisine representing a variety of local and international flavors, served with a selection of fine wines onboard. And occasionally head into town for unique included dining experiences.



LEISURE

Relax in the bar lounge cars to mingle with fellow guests, sip on an included cocktail, and watch the world glide by outside the window. Every day, your train will stop in new destinations for immersive local experiences.

CRUISE & RAIL ITINERARIES

in Europe and India

Travel like royalty on India's *Maharajas' Express*, ascend into the Swiss Alps aboard the *Golden Eagle Danube Express* to marvel at snow-capped peaks from inside your cozy cabin, traverse a path from Paris to Istanbul, perhaps the two most iconic cities in Europe, and more. Our **Cruise & Rail** itineraries are equal parts nostalgia, luxury, and adventure, each one of them offering one of the most spectacular journeys you'll ever have the opportunity to experience.

ISTANBUL TO PARIS *(New Itinerary)*

15 Days • Istanbul to Paris

S.S. Joie de Vivre & Golden Eagle Danube Express

Available option in reverse direction, 14 Days from Paris to Istanbul

Uniworld.com/CR-Istanbul-Paris

MILAN, VENICE, ISTANBUL & THE BALKANS

19 Days • Milan to Istanbul

S.S. La Venezia & Golden Eagle Danube Express

Available option without Milan, 17 Days from Venice to Istanbul

Uniworld.com/CR-Milan-Balkans

GRAND ALPINE & THE JEWELS OF VENETO

16 Days • Budapest to Venice

S.S. La Venezia & Golden Eagle Danube Express

Uniworld.com/CR-Alpine-Veneto

GRAND ALPINE & THE ENCHANTING DANUBE

15 Days • Passau to Venice

S.S. Maria Theresa & Golden Eagle Danube Express

Uniworld.com/CR-Alpine-Danube

THE SACRED GANGES & THE MAHARAJAS' EXPRESS

16 Days • Kolkata to New Delhi (or Mumbai)*

Ganges Voyager II & Maharajas' Express

**Rail portion operates from New Delhi to Mumbai on select dates.*

Uniworld.com/Cruise-Rail-India



Scan code for detailed information

Uniworld.com/Cruise-and-Rail

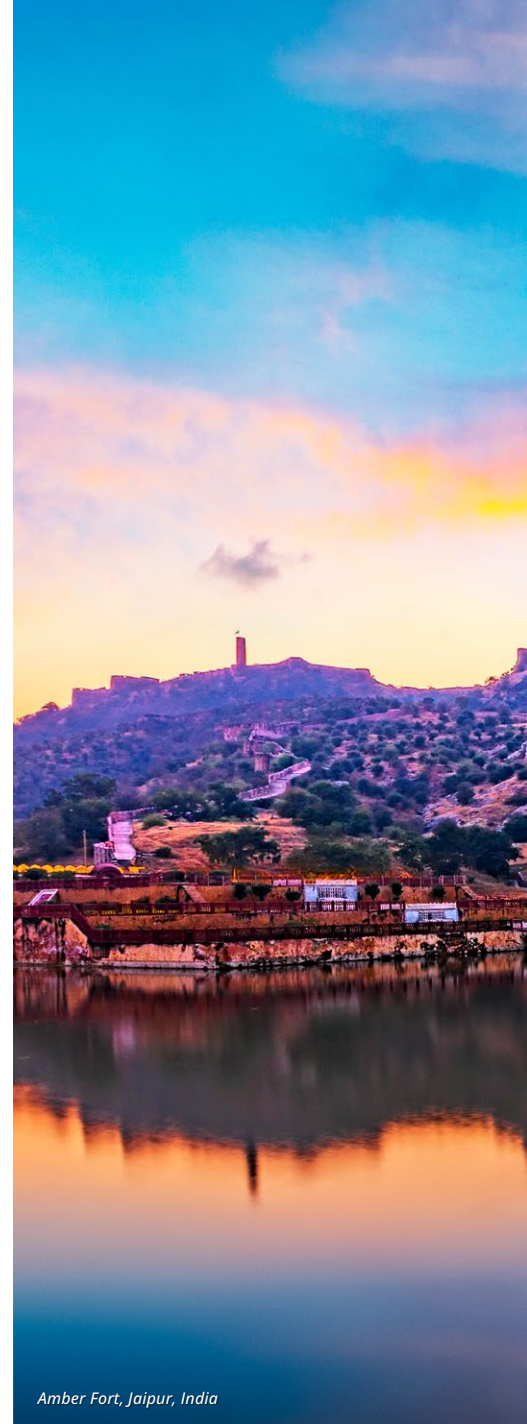

Amber Fort, Jaipur, India



Istanbul, Turkey



Golden Eagle Danube Express



Innsbruck, Austria

RIVERS OF THE WORLD

April 16 to June 5, 2026

Uniworld's 50th anniversary is coming in 2026, and we're celebrating in grand style with a 50-night *Rivers of the World* cruise! Beginning in Brussels, Belgium and ending in Amman, Jordan, this luxury adventure features several of the most incredible experiences we've developed over the decades—and in true Uniworld fashion, a handful of exciting surprises along the way.

PART 1

APRIL 16 – APRIL 26, 2026

11 Days • Brussels to Amsterdam • *S.S. Emilie*

Countries: Belgium, the Netherlands

Arrive in Brussels and settle in for a one-night stay before heading to Antwerp to embark on the first leg of the cruise.

PART 2

APRIL 26 – MAY 3, 2026

8 Days • Mystery Cruise • *Secret Ship*

Countries: *Wait and see*

A Uniworld *Mystery Cruise* is an experience unlike any other. Depart from the final port and arrive in Paris later that day.

PART 3

MAY 3 – MAY 10, 2026

8 Days • Paris to Paris • *S.S. Joie de Vivre*

Country: France

Follow the Seine River through the Normandy countryside. Depart from Paris and arrive in Lyon later that day.

PART 4

MAY 10 – MAY 20, 2026

11 Days • Lyon to Cassis • *S.S. Catherine*

Country: France

Move a little further south for an indulgent sailing through Burgundy & Provence. Depart from Cassis and arrive in Cairo later that day.

PART 5

MAY 20 – JUNE 5, 2026

17 Days • Cairo to Amman • *River Tosca*

Countries: Egypt, Jordan

The grand finale begins with 5 nights in Cairo. Next, venture down the Nile. Following the cruise, set off on a special version of our Jordan extension to cap off this once-in-a-lifetime journey.

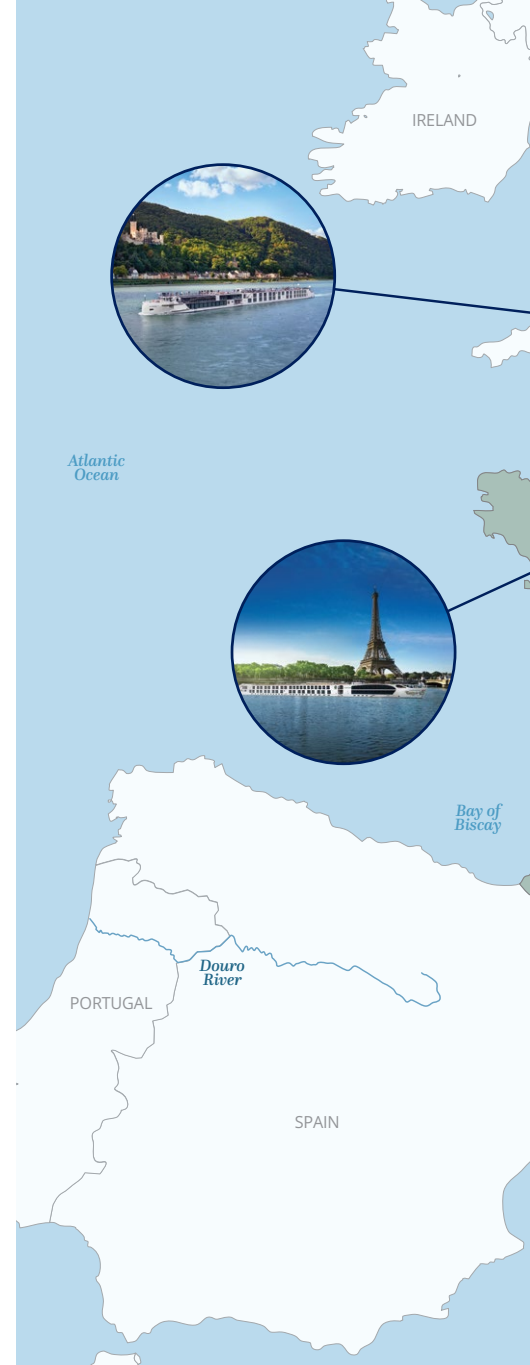

PART 1: Amsterdam, the Netherlands



PART 3: Étretat, France

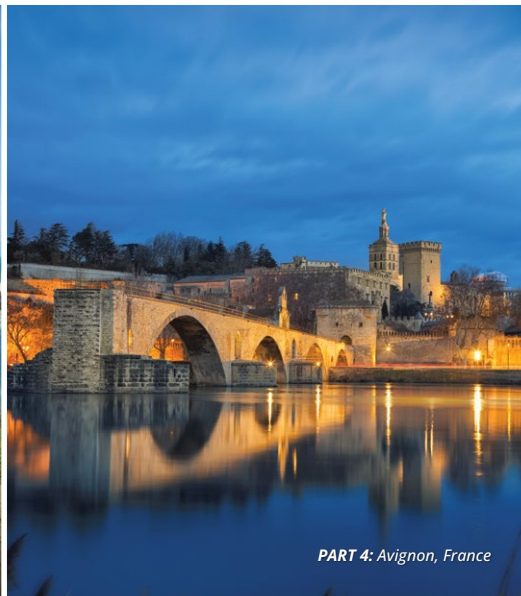

PART 4: Avignon, France



PART 5: Giza, Egypt



OUR SHIPS

One-of-a-kind floating boutique hotels



Suite, S.S. Bon Voyage

S.S. EMILIE *New for 2026*

S.S. ELISABETH *New for 2025*

S.S. VICTORIA

S.S. BEATRICE

S.S. MARIA THERESA

S.S. ANTOINETTE

RIVER PRINCESS

RIVER DUCHESS

S.S. JOIE DE VIVRE

S.S. CATHERINE

S.S. BON VOYAGE

S.S. LA VENEZIA

S.S. SÃO GABRIEL

MEKONG JEWEL

ARIA AMAZON

GANGES VOYAGER II

S.S. SPHINX

RIVER TOSCA

S.S. EMILIE

New for 2026

Inauguration: 2026 • River: Danube



Sailing the Danube River, the next member of our Super Ship fleet will be inspired by master Viennese painter Gustav Klimt. In his honor, we're naming the vessel after his beloved muse, Emilie Flöge. When she debuts in 2026, the S.S. *Emilie* will bring elements of Klimt's signature style to our guests, with dramatic hues, Art Nouveau elements, and stunning pops of gold. Guests who book a Grand Suite and the adjoining Deluxe French Balcony next door can see their stateroom transformed into an incredibly spacious 2-bedroom suite.

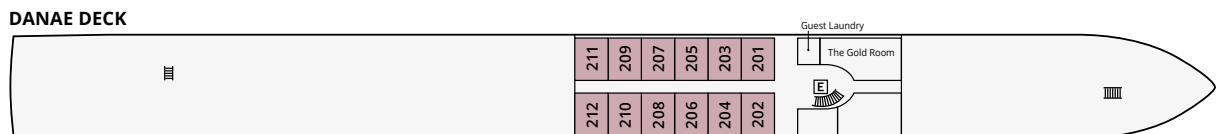
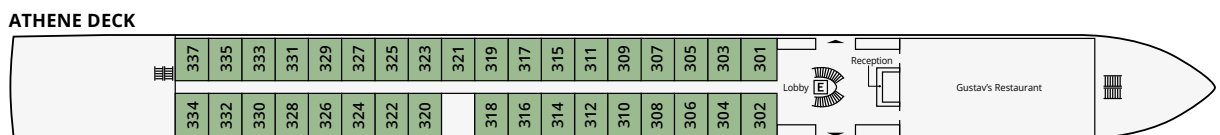
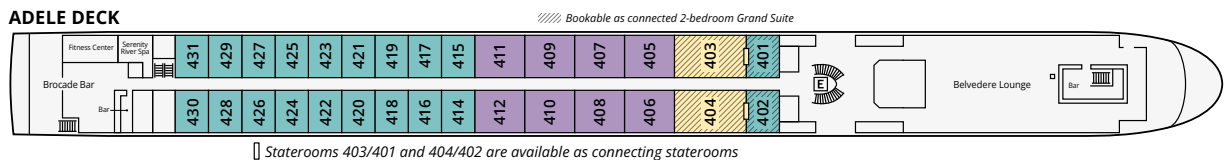
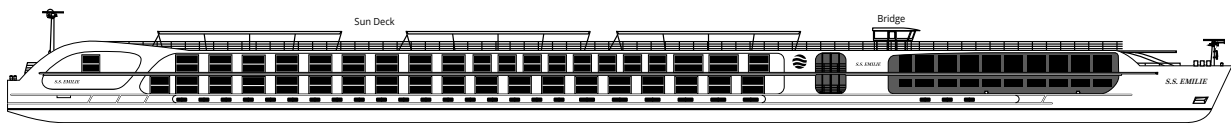

- Grand Suite**
2 (412 ft²)
- Suite**
8 (286 ft²)
- Deluxe Balcony**
20 (194 ft²)
- French Balcony**
33 (194 ft²)
- Classic**
12 (175 ft²)
- Elevator**

Note: Stateroom 301 is an Accessible Stateroom.

S.S. ELISABETH

New for 2025

Inauguration: 2017 • River: Rhine



Joining the Uniworld fleet in 2025, *S.S. Elisabeth* exudes contemporary style with luxe velvet and marble accents like her sister ship, *S.S. Victoria*. Relax amongst the soothing tones of the lounge, enjoy regionally inspired bites in one of three dining venues—including a rooftop bar—or take a dip in the onboard pool. *Tiny Noticeable Touches*, such as the original artwork lining the walls and fresh flowers, add Uniworld’s boutique flair throughout the ship.

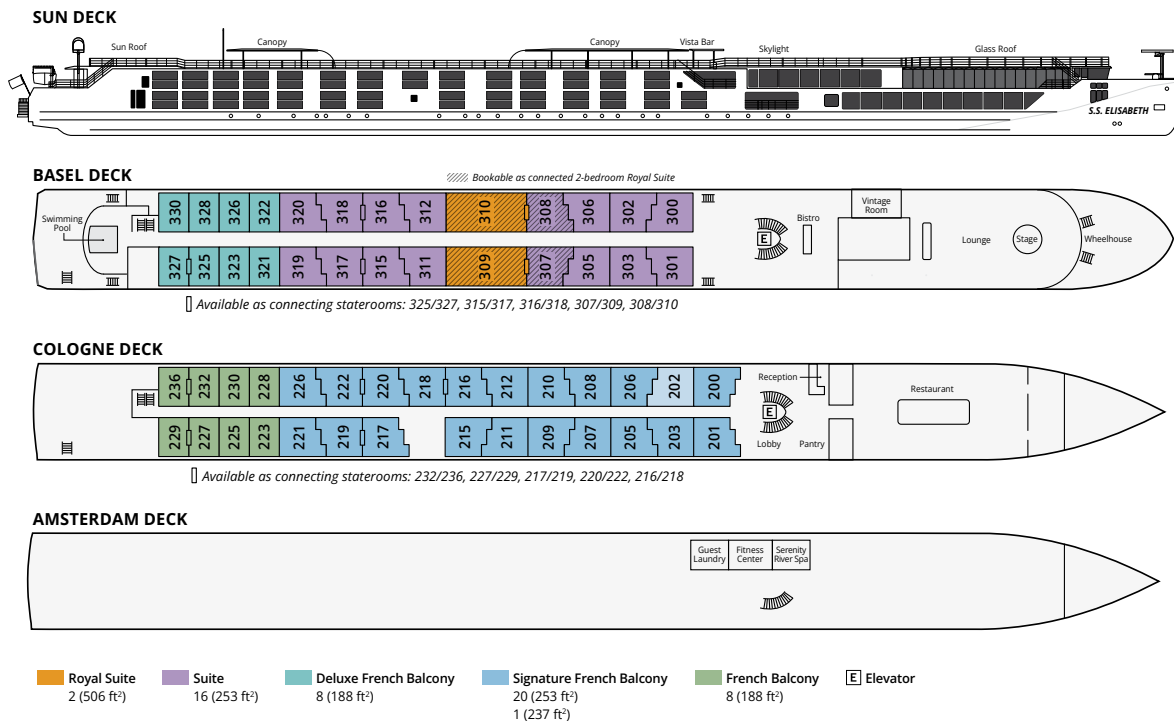

Note: Stateroom 202 is 16 ft² smaller than the other Signature French Balcony staterooms.

S.S. VICTORIA

Inauguration: 2017 • Rivers: Rhine, Moselle



Like her sister ship, the S.S. Elisabeth, the S.S. Victoria joins our European fleet with an ambiance of contemporary luxury. This ship brings the largest suites on the rivers of Europe to our fleet, boasting two Royal Suites that offer an incredible 506 square feet each. Guests can even reserve the adjoining standard Suite next door to create a 759 square foot suite with two bedrooms connected by a separate living room.

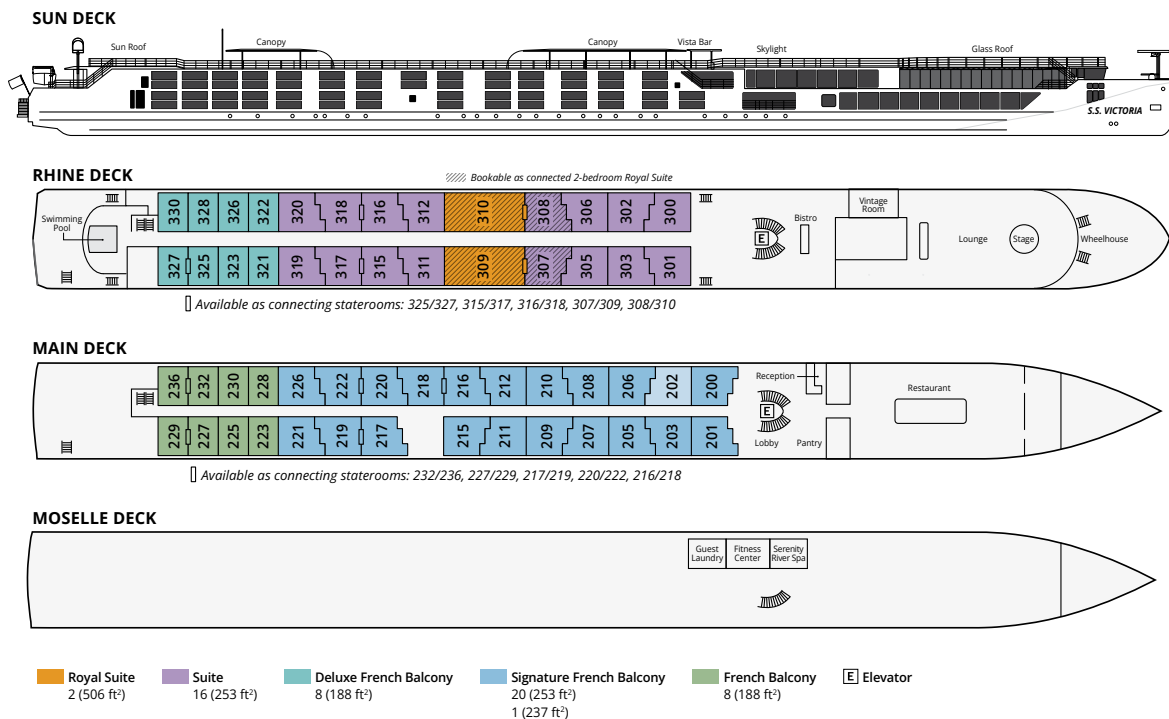

Note: Stateroom 202 is 16 ft² smaller than the other Signature French Balcony staterooms.

S.S. BEATRICE

Transformation: 2018 • Rivers: Danube, Main, Rhine



This jewel of a ship graces the waters of the Danube River, boasting splashes of nautical hues, a stunning lobby featuring elegant mirrors, marble floors, a white Murano chandelier and a grand staircase made of nickel and iron. The design inspirations include 14th-century Chinese porcelain and Dutch Delftware. *S.S. Beatrice* creates enhanced dining and culinary experiences by offering four unique venues, all inspired by famous Austrian composers.

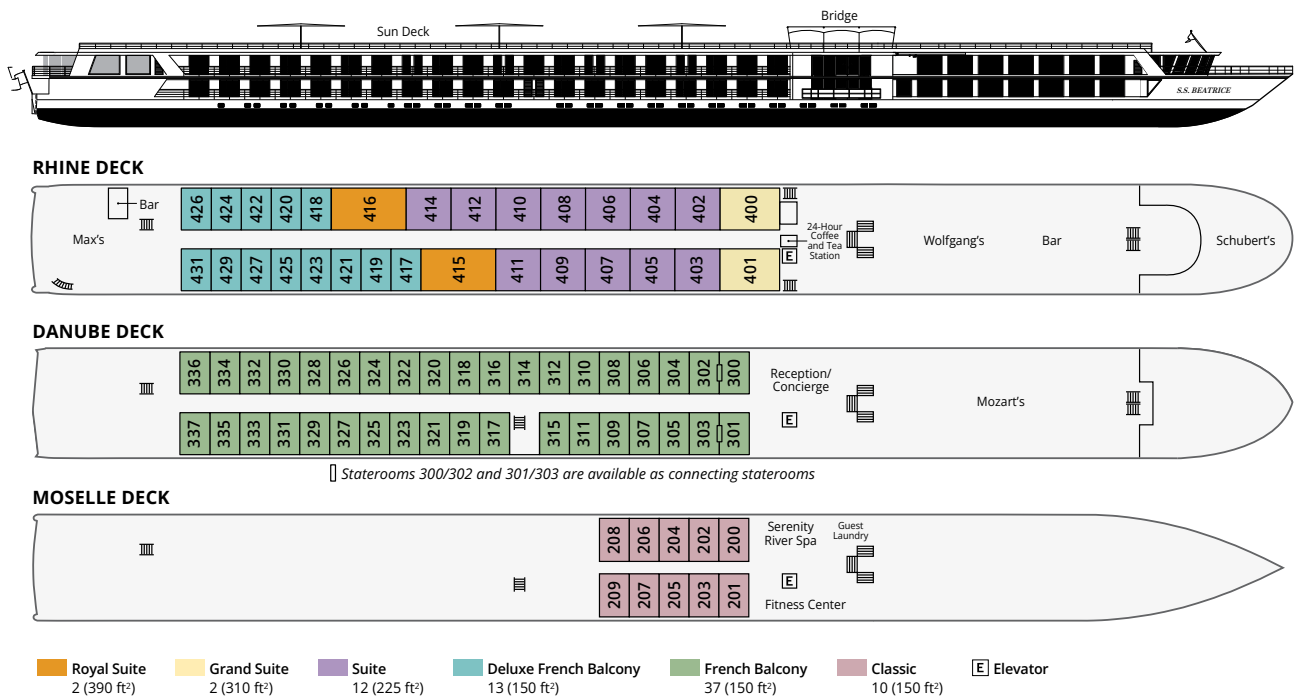

Note: All suites on the Rhine Deck have French balconies. Designated adjoining staterooms are available.

S.S. MARIA THERESA

Inauguration: 2015 • River: Danube



This splendidly elegant ship cruises along the Danube River boasting ultra-luxurious accommodations fit for Empress Maria Theresa herself. As a tribute to the only female ruler in the House of Habsburg, a 10-foot-tall, specially commissioned portrait namesake hangs in the two-story foyer. Travel like royalty surrounded by opulent silk-clad walls, a Murano glass chandelier in the lobby, eye-catching patterns in every room, hand-painted coronets, and a mosaic-tiled enclosed swimming pool.

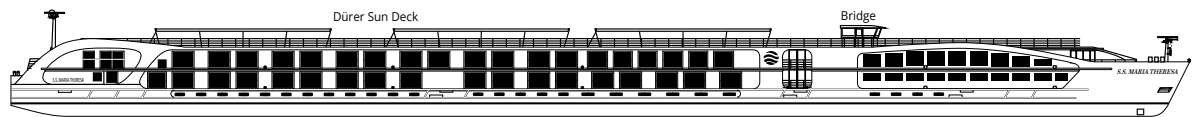

HOFBURG DECK

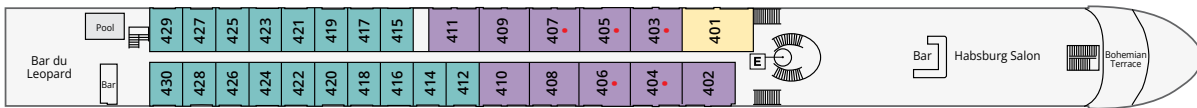

SCHÖNBRUNN DECK

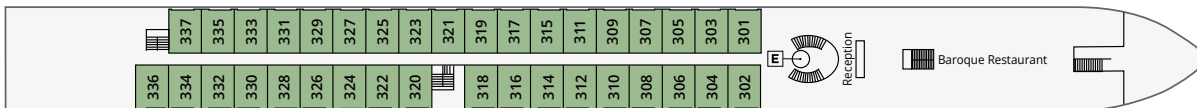

BAVARIAN DECK

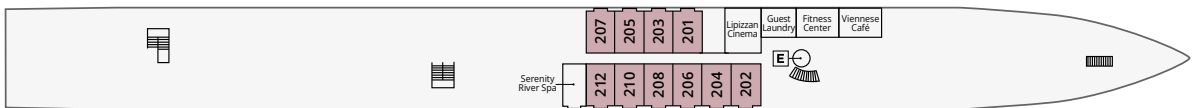

- Grand Suite
1 (140 ft²)
- Suite
10 (305 ft²)
- Deluxe Balcony
18 (194 ft²)
- French Balcony
36 (194 ft²)
- Classic
10 (162 ft²)
- E Elevator
- Triple accommodation available

Note: Staterooms and suites on the Hofburg Deck have floor-to-ceiling windows that, with the touch of a button, will raise the glass to create a completely enclosed conservatory. Designated suites provide triple-accommodation options.

S.S. ANTOINETTE

Inauguration: 2011 • River: Rhine

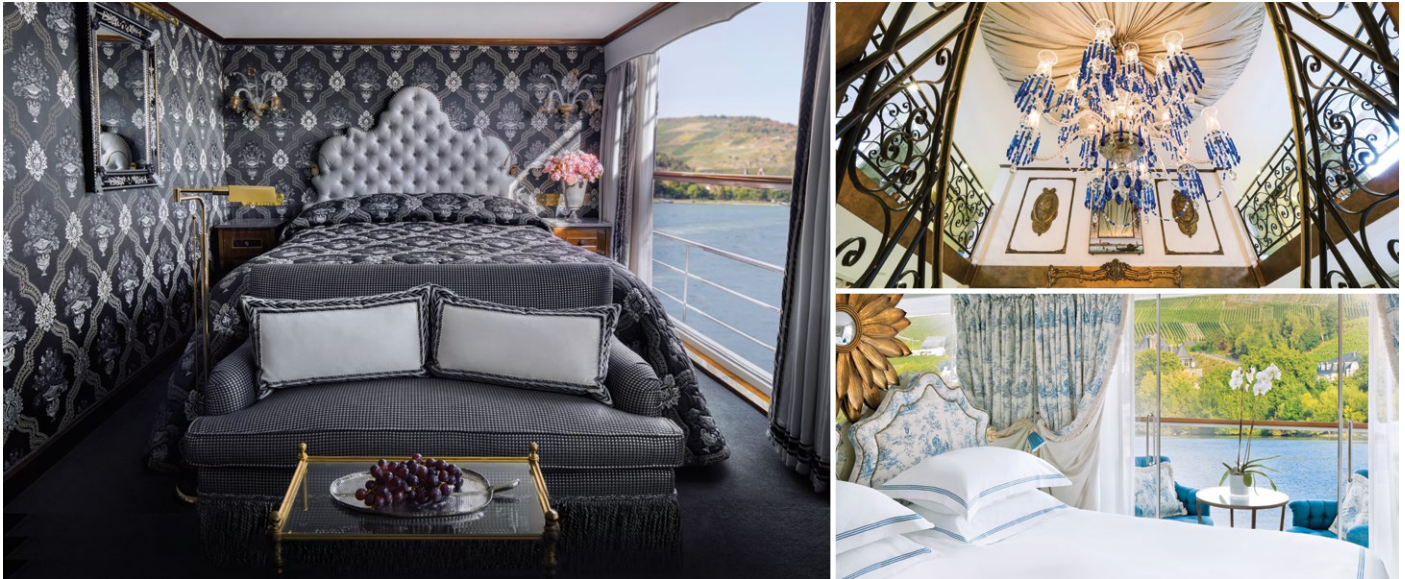

The luxurious décor of the 443-foot, 152-passenger *S.S. Antoinette*—Uniworld’s first Super Ship—features fine Brazilian marble on the walls and floors, a 19th-century Venetian glass mirror, a stylish Bar du Leopard with full-service bar, and an onboard cinema. The two-story foyer boasts a 10-foot blue Strauss Baccarat chandelier with huge sapphires—a stunning piece that once hung in New York’s famous Tavern on the Green—and a collection of original artwork is displayed throughout the ship.

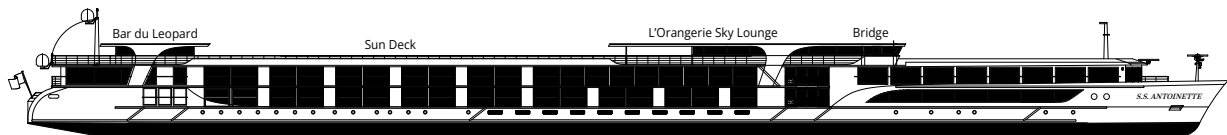

LA PRINCESSE DECK

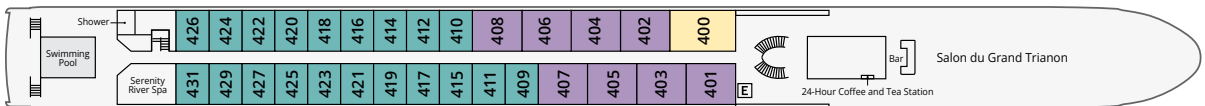

LA DUCHESSE DECK

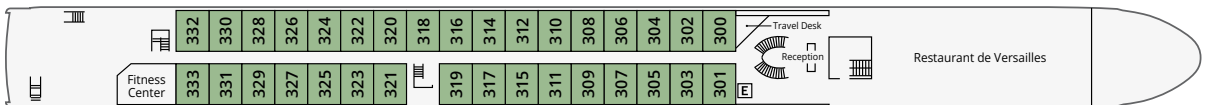

LA COUNTESSE DECK



- Grand Suite
1 (391 ft²)
- Suite
8 (294 ft²)
- Deluxe Balcony
20 (196 ft²)
- French Balcony
33 (196 ft²)
- Classic
14 (163 ft²)
- E Elevator

Note: Staterooms and suites (with the exception of the Grand Suite and Suites 402 & 403, which have been gorgeously redesigned) on the La Princesse Deck have floor-to-ceiling windows that, at the touch of a button, will raise the glass to create a completely enclosed conservatory.

RIVER PRINCESS

Transformation: 2011 • Rivers: Danube, Rhine, Main



The stunning foyer of the 128-passenger *River Princess* sets an indulgent and luxurious tone for your European journey. Warm jewel-tone greens, browns, reds and a mix of black and white seamlessly work together, providing a vibrant yet sophisticated atmosphere. Stylish public areas—including a Main Lounge, a Sky Lounge and a Captain’s Lounge and Library—provide comfortable places to curl up with a good book, chat with friends, or sip your favorite cocktail.

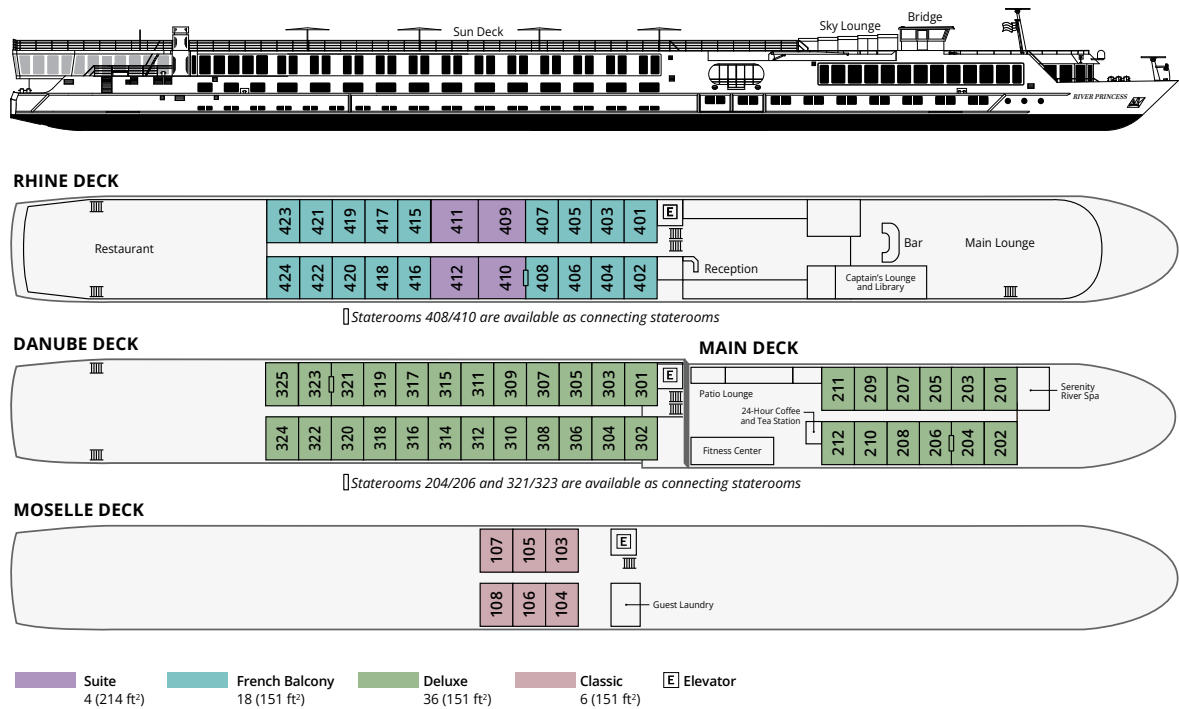

Note: Suites on the Rhine Deck have French balconies. Suites 410 & 411 have a fixed four-poster bed that cannot be separated. Designated adjoining staterooms are available.

RIVER DUCHESS

Transformation: 2012 • Rivers: Danube, Rhine, Main



The 130-passenger *River Duchess* is decorated in soft hues of blue and green complemented by soothing earth tones, providing a tranquil and elegant onboard ambiance. Enjoy spectacular and ever-changing views of Europe's most enchanting waterways in the ship's stylish Blue Danube Lounge, Palace Restaurant, or the La Motte Sky Lounge. Pay close attention to the vintage photography throughout, which features shots of James Dean, Elizabeth Taylor, Marilyn Monroe, and other noteworthy figures from the 1950s-60s.

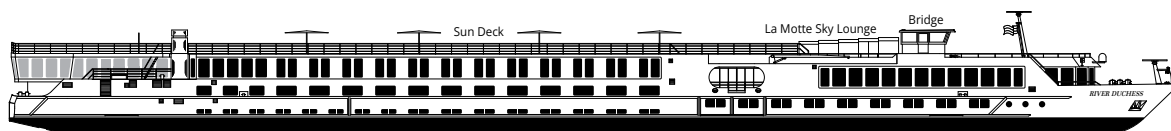

RHINE DECK

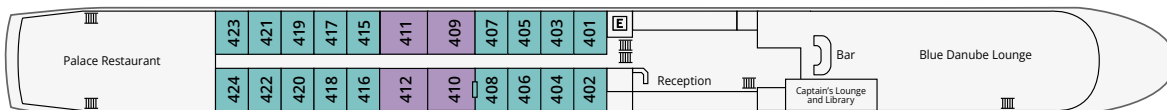

Staterooms 408/410 are available as connecting staterooms

DANUBE DECK

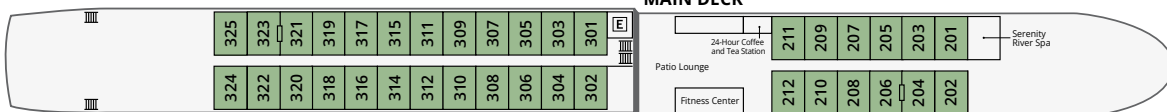

Staterooms 321/323 and 204/206 are available as connecting staterooms

MOSELLE DECK

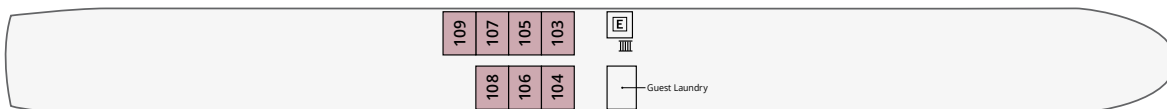

- Suite
4 (214 ft²)
- French Balcony
18 (151 ft²)
- Deluxe
36 (151 ft²)
- Classic
7 (151 ft²)
- Elevator

Note: Suites on the Rhine Deck have French balconies. Designated adjoining staterooms are available.

S.S. JOIE DE VIVRE

Inauguration: 2017 • River: Seine



S.S. *Joie de Vivre* brings the “joy of living” to the rivers of France. Step aboard your floating pied-à-terre in Paris, featuring handcrafted furniture and fine antiques, original artwork, and signature accents inspired by 20th-century Parisian design blended seamlessly with modern conveniences. The Super Ship’s attention to detail is unmatched, with fabrics and upholstery some of the most esteemed design houses in Europe.

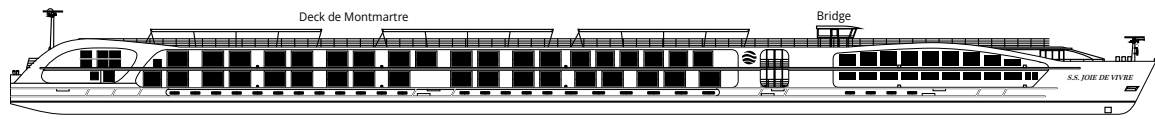

VICTOR HUGO DECK

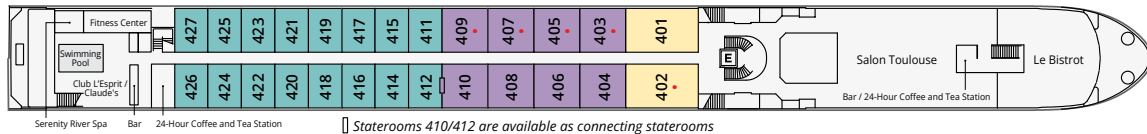

BALZAC DECK

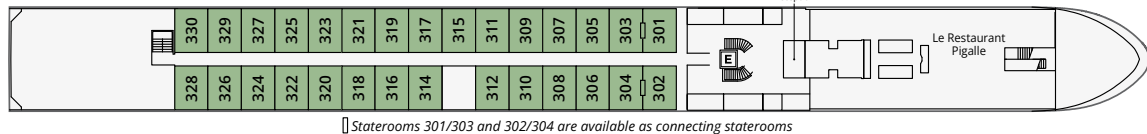

JULES VERNE DECK

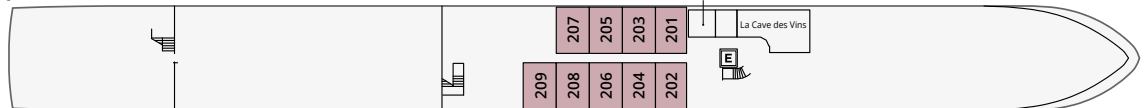

Grand Suite 2 (410 ft²)
 Suite 8 (260 ft²)
 Deluxe French Balcony 16 (194 ft²)
 French Balcony 29 (194 ft²)
 Classic 9 (162 - 180 ft²)
 [E] Elevator
• Triple accommodation available

Note: All suites on the Victor Hugo Deck have French balconies. Designated suites provide triple-accommodation options. Designated adjoining staterooms are available.

S.S. CATHERINE

Inauguration: 2014 • Rivers: Rhône, Saône



Uniworld is committed to building a Super Ship fleet that represents the absolute best in luxury river cruising, combining quality craftsmanship with high-tech innovations and custom-designed interiors. The *S.S. Catherine* continues this proud tradition of excellence with sumptuous materials and meticulous attention to detail. The vessel's exquisite interiors include a two-story lobby with a specially commissioned Murano glass chandelier and whimsical life-size glass horse by Pino Signoretto.

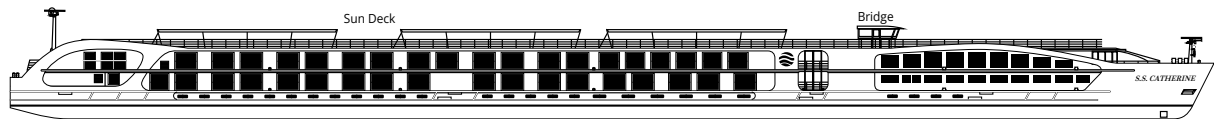

CAMARGUE DECK

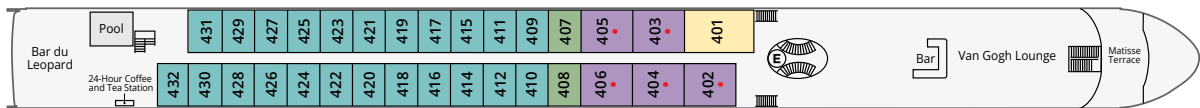

AVIGNON DECK

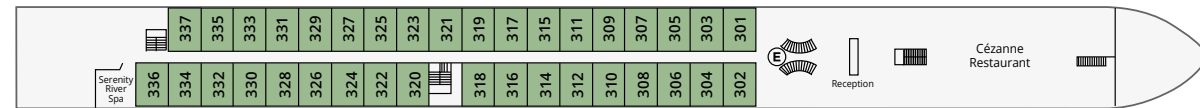

SAINT REMY DECK

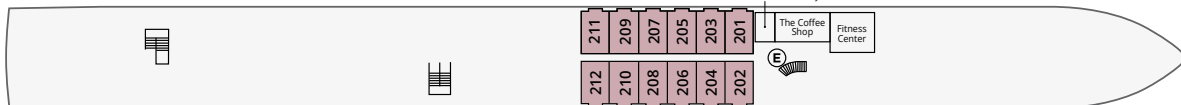

- Grand Suite
1 (410 ft²)
- Suite
5 (305 ft²)
- Deluxe Balcony
23 (194 ft²)
- French Balcony
38 (194 ft²)
- Classic
12 (162 ft²)
- E Elevator
- Triple accommodation available

Note: Deluxe balcony staterooms and suites on the Camargue Deck have floor-to-ceiling windows that, with a touch of a button, will raise the glass to create a completely enclosed conservatory. Designated suites provide triple-accommodation options.

S.S. BON VOYAGE

Transformation: 2019 • Rivers: Dordogne, Garonne



The S.S. *Bon Voyage* is designed to seamlessly immerse guests in the culture, art, and wine of the France. A stunning lobby clad in polished wood, subtle brass details, and a hand-crafted balustrade lend uncommon elegance, while the stylish sun deck boasts the river cruise industry's first and only infinity pool. An onboard bar lounge, Le Salon Champagne, is resplendent in chic emerald tones with a design inspired by Yves Saint Laurent's personal abode, Villa Majorelle. In addition to the public spaces, the S.S. *Bon Voyage* features four spacious suites, and every stateroom features an exquisite marble bathroom.

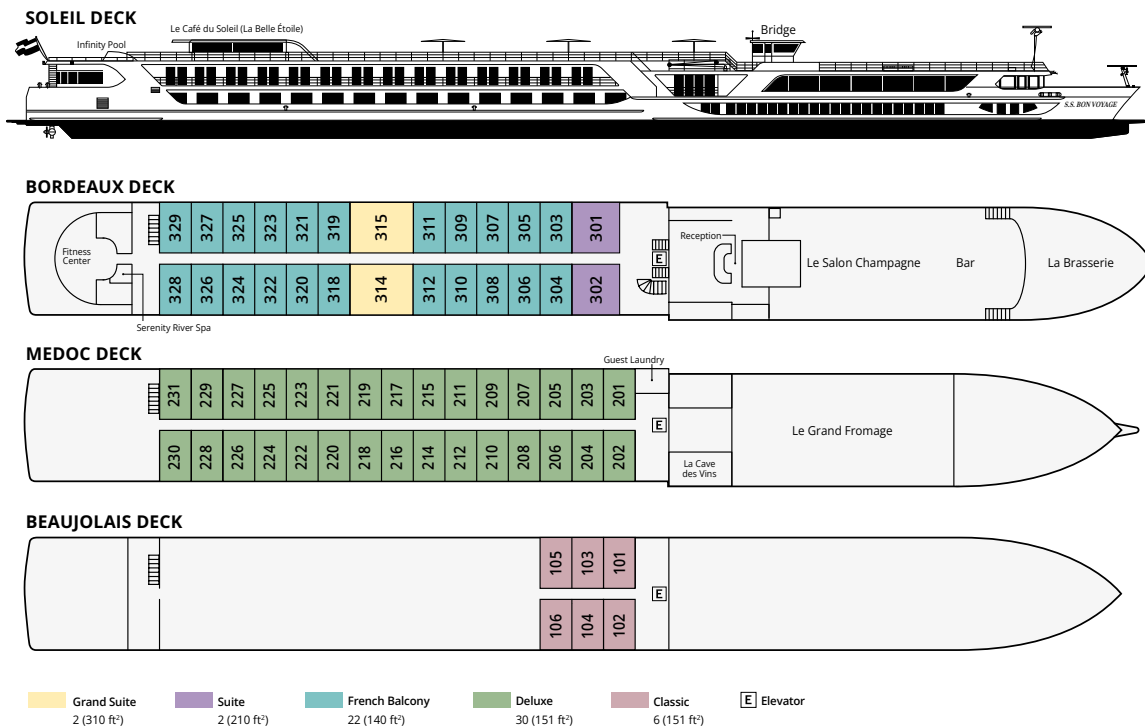

Note: French balcony staterooms, and suites on the Bordeaux deck have French balconies.

S.S. LA VENEZIA

Transformation: 2020 • River: Venice Lagoon



The S.S. *La Venezia* offers a vibrant yet sophisticated discovery of Venice and its surrounding islands, and stands witness to Italy's incomparable architecture, artistic contributions, world-renowned fashion, and famed cuisine. The redesign of this Super Ship drew influence from the fine Fortuny fabrics displayed prominently onboard. Murano glass, gilded accents and artistic etched elements pay homage to popular Venetian aesthetics of the early 20th century.

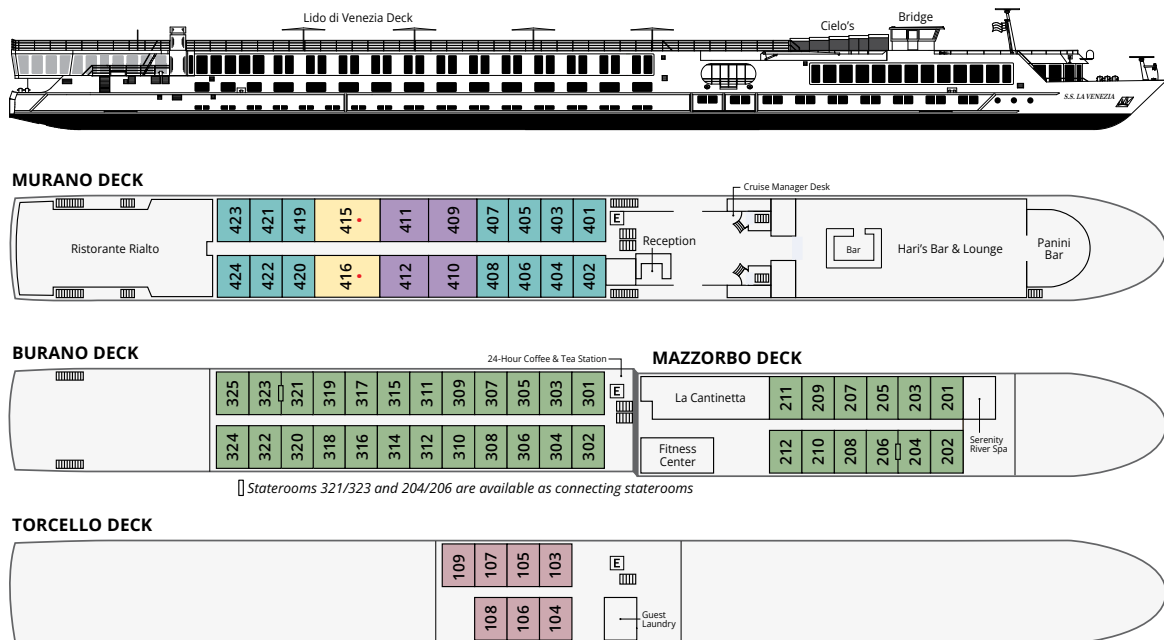

Staterooms 321/323 and 204/206 are available as connecting staterooms

Grand Suite 2 (302 ft²)
 Suite 4 (214 ft²)
 French Balcony 14 (151 ft²)
 Deluxe 36 (151 ft²)
 Classic 7 (151 ft²)
 Elevator
 Triple accommodation available

Note: Suites on the Murano Deck have French balconies. Designated suites provide triple-accommodation options. Designated adjoining staterooms are available.

S.S. SÃO GABRIEL

Inauguration: 2021 • River: Douro

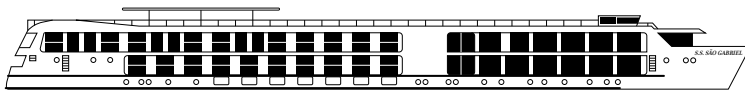

BLUE AZZELIJ TERRACE

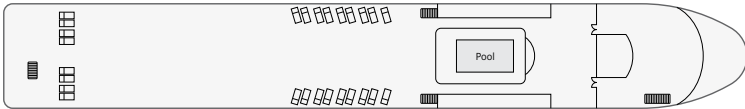

AZORES DECK

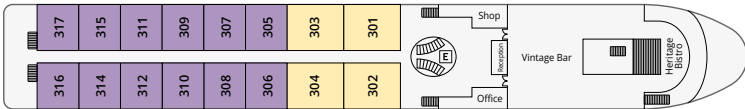

CAPE VERDE DECK

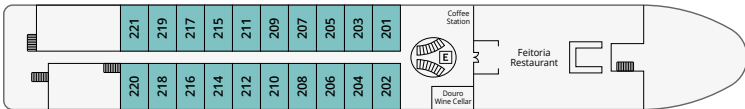

MADEIRA DECK



■ Grand Suite 4 (307 ft²)
 ■ Suite 12 (220 ft²)
 ■ French Balcony 20 (156 ft²)
 ■ Deluxe 10 (156 ft²)
 ■ Classic 4 (135 ft²)
 [E] Elevator

The S.S. *São Gabriel* embodies the spirit of Portugal. Light, airy décor throughout the ship mimics the sun-drenched nature of this fascinating country, while pops of color emphasize its vivacity and brilliant blues and greens, reflect the lush Douro River. To complete this work of art—Portugal's signature hand-made blue and white ceramic azulejos tilework can be found throughout the ship.

This chic Super Ship offers four different venues serving unlimited drinks and locally-inspired cuisine, a pool for relaxing on the sun deck while you sail past gorgeous scenery, and an entire top deck of butler-serviced suites.

Note: While the S.S. São Gabriel is the most luxurious ship on the Douro River, its amenities may differ from Uniworld company-owned ships.

MEKONG JEWEL

Inauguration: 2020 • River: Mekong

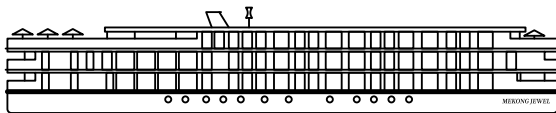

SUN DECK

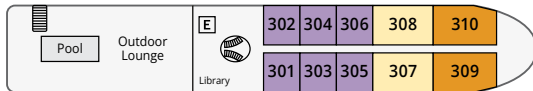

ORCHID DECK



LOTUS DECK

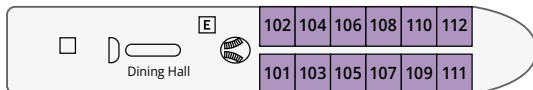

JASMINE DECK



- Royal Suite
2 (924 ft²)
- Grand Suite
2 (551 ft²)
- Suite (Balcony)
18 (339 ft²)
- Suite (Balcony)
18 (339 ft²)
- E Elevator

Experience the diverse cultures and uncharted beauty on a spectacular new Super Ship, *Mekong Jewel*. What has long been the lifeblood of Southeast Asia, the Mekong River connects six countries and offers an enthralling look at the long and glorious histories of Vietnam and Cambodia.

This incredibly spacious, multistory ship will have you charmed by your surroundings from the moment you step onboard. The all-suite *Mekong Jewel* is made of sustainable and eco-friendly materials and features artwork inspired by the landscapes of Vietnam and Cambodia, beautiful indoor and outdoor lounges, a pool, two dining venues, and a wellness center complete with a nail and hair bar.

Note: Suites on the Sun Deck and Orchid Deck have private floor-to-ceiling windows. While the Mekong Jewel is a beautiful and luxurious ship, its amenities may differ from those of a Uniworld company-owned ship. Royal and Grand suites have fixed beds that cannot be separated.

ARIA AMAZON

Inauguration: 2011 • Rivers: Marañón, Ucayali

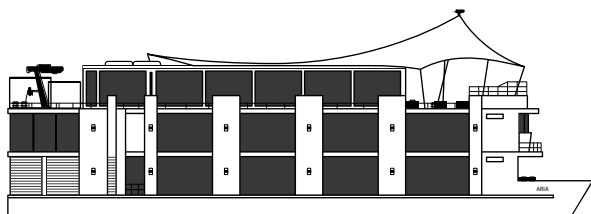

OBSERVATION DECK



SECOND DECK

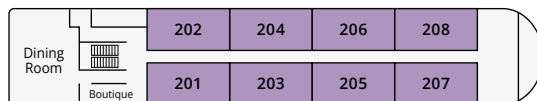

FIRST DECK

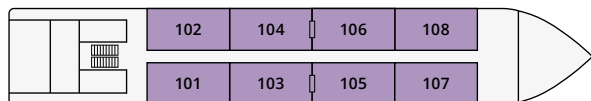

☐ Suites 103/105 and 104/106 are available as connecting suites

■ Suite
12 (225 ft²)

Designed to explore the heart of the Peruvian Amazon in luxury and comfort, the *Aria Amazon* is an all-suite ship with floor-to-ceiling windows, giving you a full view of the majestic rivers and rainforest. The top deck features a jacuzzi, indoor lounge & bar, and an outdoor observation deck.

With all-inclusive amenities and five-star cuisine by chef Pedro Miguel Schiaffino, this luxurious ship is guaranteed to give you an intimate and immersive experience.

Note: While the Aria Amazon is a beautiful and luxurious ship, its amenities may differ from those of a Uniworld company-owned ship. Designated adjoining staterooms are available.

GANGES VOYAGER II

Inauguration: 2016 • River: Ganges

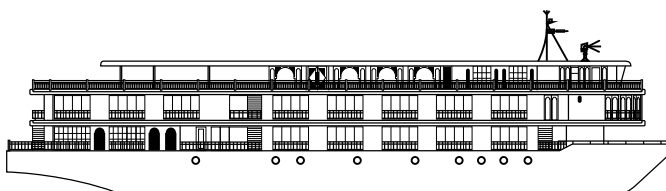

SUN DECK

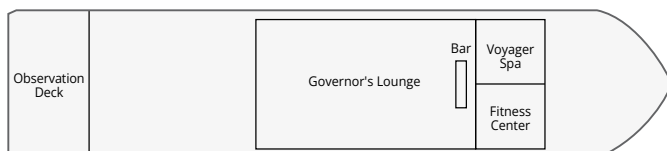

UPPER DECK

All suites on this deck have French balconies

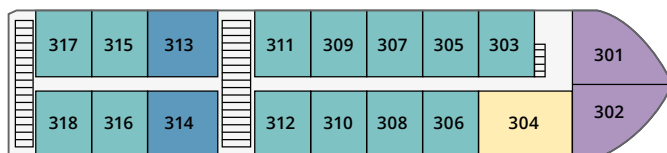

MAIN DECK

All suites on this deck have French balconies

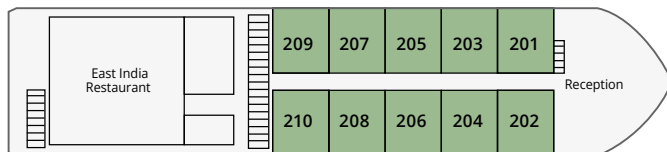

- Maharaja Suite**
1 (400 ft²)
- Viceroy Suite**
2 (360 ft²)
- Heritage Suite**
2 (280 ft²)
- Signature Suite**
10 (261 ft²)
- Colonial Suite**
13 (261 ft²)

The ship's spacious, high-ceilinged suites are a serene sanctuary, with beautiful hand-painted murals and all the comforts of a five-star hotel. All suites have a cozy sitting area and a French balcony with floor-to-ceiling glass doors. A bed dressed in soft linens, with a choice of pillows. Your roomy bathroom has a rain shower, comfy robes and slippers, and spa-quality bath products.

Other high-end amenities include a generous amount of closet space, under-bed storage, a flat-screen television with a wide selection of on-demand movies, individual climate control, bottled water replenished daily, fresh fruit and flowers upon arrival, makeup mirrors, and universal electrical plugs.

Note: While the Ganges Voyager II is a beautiful and luxurious ship, its amenities may differ from those of a Uniworld company-owned ship. Maharaja, Viceroy and Heritage Suites have fixed beds that cannot be separated.

S.S. SPHINX

Inauguration: 2021 • River: Nile

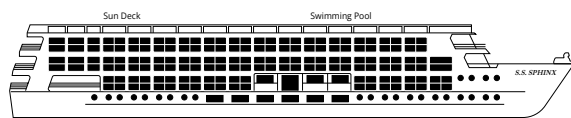

KARNAK DECK

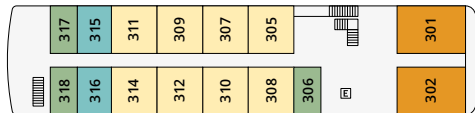

ABU SIMBEL DECK

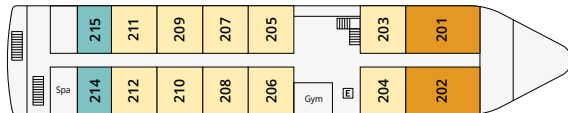

DENDERA DECK

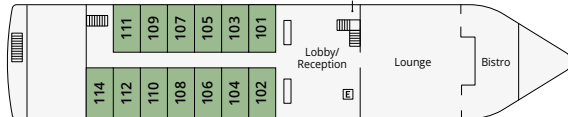

LUXOR DECK



- Royal Suite
4 (592 ft²)
- Grand Suite
18 (430 ft²)
- Deluxe French Balcony
4 (301 ft²)
- French Balcony
16 (233 ft²)
- E Elevator

The S.S. *Sphinx* offers two gourmet dining venues, gym, swimming pool, massage room, gorgeously appointed suites, and stunning French balcony staterooms, not to mention, sweeping views of the longest river in the world. This Super Ship offers an immersive onboard experience, with bespoke décor by local artisans and materials sourced regionally—such as fine Egyptian cottons, marble and hand-carved blonde wood—to highlight Egyptian craftsmanship while minimizing our carbon footprint. Capturing the essence of the Great Sphinx, S.S. *Sphinx* will steer you to numerous bucket-list destinations, filling you with endless wonder as you sail past man-made marvels, wonders of the world, and ancient temple complexes.

Note: All staterooms and suites onboard have French balconies. While the S.S. Sphinx is a beautiful and luxurious ship, its amenities may differ from those of a Uniworld company-owned ship. Designated adjoining staterooms available for 301/303 and 302/304.

RIVER TOSCA

Inauguration: 2009 • River: Nile

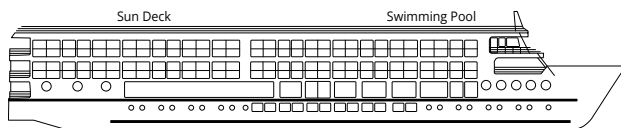

PYRAMID DECK

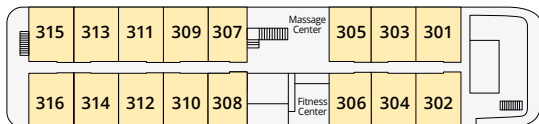

PHARAOH DECK

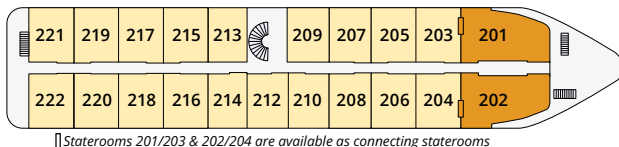

CAIRO DECK

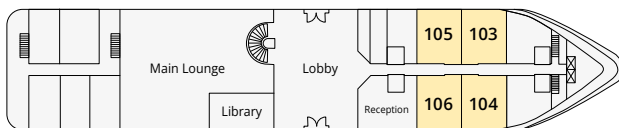

NILE DECK

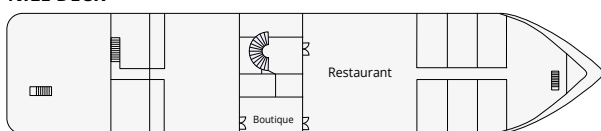

Royal Suite 2 (651 ft²)
Grand Suite 39 (313-335 ft²)

The *River Tosca* perfectly captures the warmth and style of Egypt, taking guests on a culturally enriching adventure down the Nile in absolute luxury. This all-suite ship is elegantly designed with wood finishes and cozy public spaces.

From the sprawling Sun Deck with shaded cabanas and a swimming pool, to the stylish lounge decorated with local wares, every space is inspired by the region in which it sails. Comfortable suites are fitted with the finest locally made products—like Egyptian cotton linens, for example. With a maximum capacity of 82 guests and a staff to guest ratio of almost 1 to 1, a cruise on the *River Tosca* is about as intimate and indulgent as it gets.

Note: While the River Tosca is a luxury vessel, its amenities may differ from those of a Uniworld company-owned ship. Designated adjoining staterooms available.





You deserve the best.

VISIT [UNIWORLD.COM](https://uniworld.com) · CALL 800-733-7820 · CONTACT YOUR PREFERRED TRAVEL ADVISOR



#EXPLOREUNIWORLD

Terms and conditions can be found at [Uniworld.com/Terms-and-Conditions](https://uniworld.com/terms-and-conditions). Uniworld is not responsible for omissions, printing and/or presentation errors in brochures, on internet sites, or in any other media where such information may be presented; Uniworld reserves the right to make corrections as required.

CST #2075415-20
TICO Reg. #50018458

